

Liquidyn P-Dot Series Jet Valves

Operating Manual



 **WATCH VIDEOS**
www.nordsonefd.com/LQMaintVideos

Electronic pdf files of Nordson EFD manuals are also available at www.nordsonefd.com



You have selected a reliable, high-quality dispensing system from Nordson EFD, the world leader in fluid dispensing. The Liquidyn® P-Dot Series jet valve was designed specifically for industrial dispensing and will provide you with years of trouble-free, productive service.

This manual will help you maximize the usefulness of your Liquidyn P-Dot valve

Please spend a few minutes to become familiar with the controls and features. Follow our recommended testing procedures. Review the helpful information we have included, which is based on more than 50 years of industrial dispensing experience.

Most questions you will have are answered in this manual. However, if you need assistance, please do not hesitate to contact EFD or your authorized EFD distributor. Detailed contact information is provided on the last page of this document.

The Nordson EFD Pledge

Thank You!

You have just purchased the world's finest precision dispensing equipment.

I want you to know that all of us at Nordson EFD value your business and will do everything in our power to make you a satisfied customer.

If at any time you are not fully satisfied with our equipment or the support provided by your Nordson EFD Product Application Specialist, please contact me personally at 800.556.3484 (US), 401.431.7000 (outside US), or Jamie.Clark@nordsonefd.com.

I guarantee that we will resolve any problems to your satisfaction.

Thanks again for choosing Nordson EFD.

Jamie
Jamie Clark, Vice President

Contents

Contents	3
Introduction	5
How the Valve Operates	5
How the Valve is Controlled.....	5
Nordson EFD Product Safety Statement	6
Halogenated Hydrocarbon Solvent Hazards	7
High Pressure Fluids.....	7
Qualified Personnel.....	7
Intended Use	8
Regulations and Approvals.....	8
Personal Safety.....	8
Fire Safety.....	9
Preventive Maintenance	9
Important Disposable Component Safety Information	10
Action in the Event of a Malfunction	10
Disposal	10
Equipment-Specific Safety Information.....	11
Specifications.....	12
Operating Features.....	13
Installation	14
Unpack the System Components.....	14
Assemble the Valve (Initial Assembly).....	15
Install a Nozzle Heater (Optional).....	17
Mount the Valve.....	18
Connect Cables	19
Connect the Air Supply.....	20
Installation Example.....	21
Initial Startup.....	22
Parameter Settings	23
Recommended Setup Adjustments.....	24
Tappet Adjustment	25
Adjusting the Force Screw	25
Returning the Force Screw to the Factory Setting.....	27
Manually Setting the Force Screw for Multiple Valves.....	28
Service.....	30
Recommended Maintenance Schedule.....	30
Valve Cleaning	30
Shut Down the System	31
Disassemble the Valve	31
Clean the Valve Components.....	33
Assemble the Valve (After Cleaning)	34
Tappet Replacement	36

Continued on next page

Contents (continued)

Part Number	38
Replacement Parts	38
Valve Components	38
Nozzles and Nozzle Retaining Nuts	39
Syringe Barrels and Accessories	40
Material Supply Tubing Components	41
Steel Tubing Connectors	41
Tubing	41
Accessories	41
Quick-Release Valve Mounting Components	41
Precision Pressure Regulator	41
Nozzle Heaters.....	42
Nozzle Heater Kits.....	43
Nozzle Heater Cables.....	43
Nozzle Heater O-Rings.....	43
Heater Key	43
Tools and Supplies	44
Technical Data.....	45
Dimensions	45
M8 Valve Cable Pin Positions.....	45
Appendix A, About Non-Contact Dispensing.....	46
Appendix B, P-Dot Valve Interface Overview.....	47
Electrical Control	47
Optional Nozzle Heater Control.....	48
Pneumatic Control.....	49
Valve Configuration Options.....	49

Introduction

The Liquidyn P-Dot is a high performance jet valve designed for the non-contact micro-dispensing of medium- to high-viscosity fluids, including oils, greases, adhesives, silicones, lacquers, fluxes, and medical and chemical substances.

Valve Speed and Deposit Size

The valve can produce micro-deposits ranging in size from 0.3–5.0 mm at dispensing frequencies of up to 150Hz, for a faster production process. The distance between the valve and the substrate is usually between 2 and 10 mm.

Modular, Exchangeable Components

Because the material-carrying components are separate from the actuator, dispensing nozzles can be quickly and easily exchanged. The exchangeable design makes material-type change-out and component replacement fast and easy.

The Liquidyn P-Dot valve is configurable. Several choices for the material supply components and sealing options are available, and an optional nozzle heater can be installed to warm material at the nozzle.

How the Valve Operates

The Liquidyn P-Dot valve is electro-pneumatically operated by a low voltage, 2 ms pulse signal. The dispensing tappet remains open until the trigger signal ends. The valve is normally closed (NC) when idle, thus reducing the possibility of unintended fluid release upon power off.

How the Valve is Controlled

The valve can be operated using a Nordson EFD Liquidyn controller or directly by the customer via a 24V input using a customer-supplied controller or a programmable logic controller (PLC).



Liquidyn P-Dot micro-dispensing valve with a syringe barrel material supply



The Liquidyn V200 controller can be used to control the operation of the Liquidyn P-Dot valve

Nordson EFD Product Safety Statement

WARNING

The safety message that follows has a WARNING level hazard.
Failure to comply could result in death or serious injury.



ELECTRIC SHOCK

Risk of electric shock. Disconnect power before removing covers and / or disconnect, lock out, and tag switches before servicing electrical equipment. If you receive even a slight electrical shock, shut down all equipment immediately. Do not restart the equipment until the problem has been identified and corrected.

CAUTION

The safety messages that follow have a CAUTION level hazard.
Failure to comply may result in minor or moderate injury.



READ MANUAL

Read manual for proper use of this equipment. Follow all safety instructions. Task- and equipment-specific warnings, cautions, and instructions are included in equipment documentation where appropriate. Make sure these instructions and all other equipment documents are accessible to persons operating or servicing equipment.



MAXIMUM AIR PRESSURE

Unless otherwise noted in the product manual, the maximum air input pressure is 7.0 bar (100 psi). Excessive air input pressure may damage the equipment. Air input pressure is intended to be applied through an external air pressure regulator rated for 0 to 7.0 bar (0 to 100 psi).



RELEASE PRESSURE

Release hydraulic and pneumatic pressure before opening, adjusting, or servicing pressurized systems or components.



BURNS

Hot surfaces! Avoid contact with the hot metal surfaces of heated components. If contact can not be avoided, wear heat-protective gloves and clothing when working around heated equipment. Failure to avoid contact with hot metal surfaces can result in personal injury.

Nordson EFD Product Safety Statement (continued)

Halogenated Hydrocarbon Solvent Hazards

Do not use halogenated hydrocarbon solvents in a pressurized system that contains aluminum components. Under pressure, these solvents can react with aluminum and explode, causing injury, death, or property damage. Halogenated hydrocarbon solvents contain one or more of the following elements.

Element	Symbol	Prefix
Fluorine	F	“Fluoro-”
Chlorine	Cl	“Chloro-”
Bromine	Br	“Bromo-”
Iodine	I	“Iodo-”

Check the Safety Data Sheet (SDS) or contact your material supplier for more information. If you must use halogenated hydrocarbon solvents, contact your EFD representative for compatible EFD components.

High Pressure Fluids

High pressure fluids, unless they are safely contained, are extremely hazardous. Always release fluid pressure before adjusting or servicing high pressure equipment. A jet of high pressure fluid can cut like a knife and cause serious bodily injury, amputation, or death. Fluids penetrating the skin can also cause toxic poisoning.

WARNING

Any injury caused by high pressure liquid can be serious. If you are injured or even suspect an injury:

- Go to an emergency room immediately.
- Tell the doctor that you suspect an injection injury.
- Show the doctor the following note.
- Tell the doctor what kind of material you were dispensing.

Medical Alert — Airless Spray Wounds: Note to Physician

Injection in the skin is a serious traumatic injury. It is important to treat the injury surgically as soon as possible. Do not delay treatment to research toxicity. Toxicity is a concern with some exotic coatings injected directly into the bloodstream.

Qualified Personnel

Equipment owners are responsible for making sure that EFD equipment is installed, operated, and serviced by qualified personnel. Qualified personnel are those employees or contractors who are trained to safely perform their assigned tasks. They are familiar with all relevant safety rules and regulations and are physically capable of performing their assigned tasks.

Nordson EFD Product Safety Statement (continued)

Intended Use

Use of EFD equipment in ways other than those described in the documentation supplied with the equipment may result in injury to persons or damage to property. Some examples of unintended use of equipment include:

- Using incompatible materials.
- Making unauthorized modifications.
- Removing or bypassing safety guards or interlocks.
- Using incompatible or damaged parts.
- Using unapproved auxiliary equipment.
- Operating equipment in excess of maximum ratings.
- Operating equipment in an explosive atmosphere.

Regulations and Approvals

Make sure all equipment is rated and approved for the environment in which it is used. Any approvals obtained for Nordson EFD equipment will be voided if instructions for installation, operation, and service are not followed. If the equipment is used in a manner not specified by Nordson EFD, the protection provided by the equipment may be impaired.

Personal Safety

To prevent injury, follow these instructions:

- Do not operate or service equipment unless you are qualified.
- Do not operate equipment unless safety guards, doors, and covers are intact and automatic interlocks are operating properly. Do not bypass or disarm any safety devices.
- Keep clear of moving equipment. Before adjusting or servicing moving equipment, shut off the power supply and wait until the equipment comes to a complete stop. Lock out power and secure the equipment to prevent unexpected movement.
- Make sure spray areas and other work areas are adequately ventilated.
- When using a syringe barrel, always keep the dispensing end of the tip pointing towards the work and away from the body or face. Store syringe barrels with the tip pointing down when they are not in use.
- Obtain and read the Safety Data Sheet (SDS) for all materials used. Follow the manufacturer's instructions for safe handling and use of materials and use recommended personal protection devices.
- Be aware of less-obvious dangers in the workplace that often cannot be completely eliminated, such as hot surfaces, sharp edges, energized electrical circuits, and moving parts that cannot be enclosed or otherwise guarded for practical reasons.
- Know where emergency stop buttons, shutoff valves, and fire extinguishers are located.
- Wear hearing protection to protect against hearing loss that can be caused by exposure to vacuum exhaust port noise over long periods of time.

Nordson EFD Product Safety Statement (continued)

Fire Safety

To prevent a fire or explosion, follow these instructions:

- Shut down all equipment immediately if you notice static sparking or arcing. Do not restart the equipment until the cause has been identified and corrected.
- Do not smoke, weld, grind, or use open flames where flammable materials are being used or stored.
- Do not heat materials to temperatures above those recommended by the manufacturer. Make sure heat monitoring and limiting devices are working properly.
- Provide adequate ventilation to prevent dangerous concentrations of volatile particles or vapors. Refer to local codes or the SDS for guidance.
- Do not disconnect live electrical circuits when working with flammable materials. Shut off power at a disconnect switch first to prevent sparking.
- Know where emergency stop buttons, shutoff valves, and fire extinguishers are located.

Preventive Maintenance

As part of maintaining continuous trouble-free use of this product, Nordson EFD recommends the following simple preventive maintenance checks:

- Periodically inspect tube-to-fitting connections for proper fit. Secure as necessary.
- Check tubing for cracks and contamination. Replace tubing as necessary.
- Check all wiring connections for looseness. Tighten as necessary.
- Clean: If a front panel requires cleaning, use a clean, soft, damp rag with a mild detergent cleaner. DO NOT USE strong solvents (MEK, acetone, THF, etc.) as they will damage the front panel material.
- Maintain: Use only a clean, dry air supply to the unit. The equipment does not require any other regular maintenance.
- Test: Verify the operation of features and the performance of equipment using the appropriate sections of this manual. Return faulty or defective units to Nordson EFD for replacement.
- Use only replacement parts that are designed for use with the original equipment. Contact your Nordson EFD representative for information and advice.

Nordson EFD Product Safety Statement (continued)

Important Disposable Component Safety Information

All Nordson EFD disposable components, including syringe barrels, cartridges, pistons, tip caps, end caps, and dispense tips, are precision engineered for one-time use. Attempting to clean and re-use components will compromise dispensing accuracy and may increase the risk of personal injury.

Always wear appropriate protective equipment and clothing suitable for your dispensing application and adhere to the following guidelines:

- Do not heat syringe barrels or cartridges to a temperature greater than 38° C (100° F).
- Dispose of components according to local regulations after one-time use.
- Do not clean components with strong solvents (MEK, acetone, THF, etc.).
- Clean cartridge retainer systems and barrel loaders with mild detergents only.
- To prevent fluid waste, use Nordson EFD SmoothFlow™ pistons.

Action in the Event of a Malfunction

If a system or any equipment in a system malfunctions, shut off the system immediately and perform the following steps:

1. Disconnect and lock out system electrical power. If using hydraulic and pneumatic shutoff valves, close and relieve pressure.
2. For Nordson EFD air-powered dispensers, remove the syringe barrel from the adapter assembly. For Nordson EFD electro-mechanical dispensers, slowly unscrew the barrel retainer and remove the barrel from the actuator.
3. Identify the reason for the malfunction and correct it before restarting the system.

Disposal

Dispose of equipment and materials used in operation and servicing according to local codes.

Nordson EFD Product Safety Statement (continued)

Equipment-Specific Safety Information

The following safety information is specific to the Liquidyn P-Dot valve.

CAUTION

Do not dry cycle the valve! The valve be damaged if it is operated without fluid, causing leakage and a poor seal. Precise dispensing can no longer be guaranteed if this occurs.

General

- Before use, read the complete operating instructions and all safety instructions to ensure safe and correct usage.
- Observe all safety instructions.

Intended Use

- The micro-dispensing system is for indoor use only.
- Do not use the micro-dispensing system in an explosive atmosphere or with explosive materials.

Fluid Compatibility

- Use only for the micro-dispensing of medium- to high-viscosity fluids or pastes.
- Ensure that all fluid carrying parts and sealings are resistant to the dispensing material used.

Operating Conditions

- Operate heaters (optional) within the approved temperature range only. Refer to “Specifications” on page 12.
- Use only heaters that are distributed by Nordson EFD specifically for this micro-dispensing valve.
- Adhere to the maintenance intervals specified under “Service” on page 30.
- Do not subject the valve needle to force, knocks, or impact.
- Avoid long shutdown periods with the system switched on.
- Do not operate the valve in a dry condition (without dispensing material).

Specifications

NOTE: Specifications and technical details are subject to change without prior notification.

Item	Specification
Size	Refer to “Dimensions” on page 45.
Weight	270.0 g (9.5 oz)
Maximum fluid pressure	100 bar (1,450 psi)
Fluid inlet	M8 x 1, flat sealing
Mounting	M3 x 25
Maximum operating frequency	150Hz
Pulse time	2 ms
Input voltage	24 VDC, PLC compatible
Power consumption	0.5 Amp (peak 5.0 Amp)
Input air pressure	2.0–5.0 bar (29–73 psi)
Maximum valve temperature	40° C (104° F) NOTE: Refer also to the manufacturer’s safety data sheet (SDS) for the material to be dispensed for the required ambient operating conditions
Maximum nozzle heater temperature	90° C (194° F)
Fluid body	303 stainless steel
Heater body	Aluminum
Humidity	10–80%
Storage temperature	-5–40° C (23–104° F)
Dispensing volume	3–200 nL (1–6.8 oz) per cycle
Viscosity range	50–200,000 mPas (thixotropic)
Dispensing accuracy	>99% (dispensing tolerance <1%)
Service life	>100,000,000 cycles
Product classification	IP65 Installation category II
Compressed air quality class	Pollution degree DIN ISO 8573-1, class 5
Approvals	CE*, TÜV
*This valve meets the EN 61326-1:2013, FCC Part 15 Subpart B, and ICES-003 Issue 6 product family standard for immunity and emissions when connected to a Nordson EFD Liquidyn controller. Usage with any other controller does not guarantee electromagnetic compatibility (EMC) performance.	

Operating Features

The Liquidyn P-Dot micro-dispensing valve is shipped with the components shown under “Unpack the System Components” on page 14, along with any additional configuration selections and accessories. The valve can be uniquely configured to achieve the best dispensing result for your material and application.

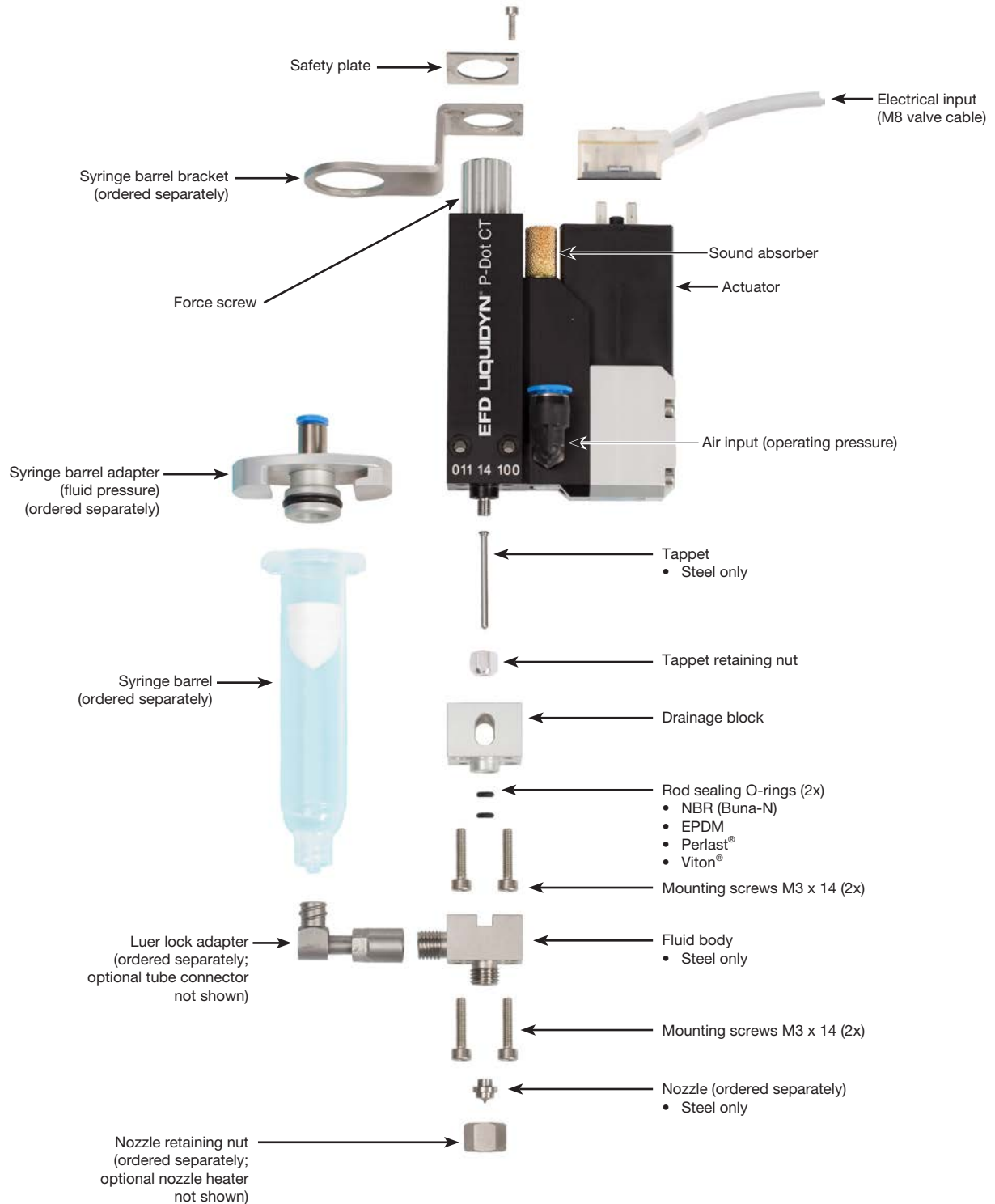

Installation

Use this section in tandem with any other system component operating manuals to install all components of the system.

Unpack the System Components

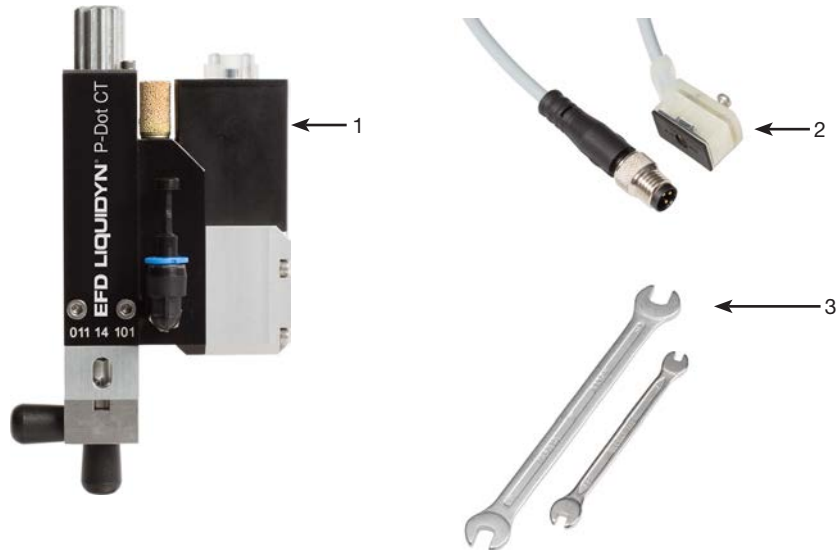

- 1 Liquidyn P-Dot valve equipped with the following parts:
 - Actuator
 - Safety plate
 - Steel fluid body
 - Drainage block
 - 4 mounting screws
 - 2 NBR O-rings (between the tappet rod and fluid body)
 - Steel tappet with tappet nut
- 2 2.5 m (8.2 ft) M8 valve cable with 3-pin plug
- 3 Open-end wrench, size 3.5 mm
Open-end wrench, size 6 mm

(Not shown)

Optional components (ordered and shipped separately)

Assemble the Valve (Initial Assembly)

Follow this procedure to assemble the valve before mounting it. You will need the following items:

- Open-end wrench, size 10 mm
- Hex wrench, size 2.5 mm
- Hex wrench, size 1.5 mm
- Nozzle
- Nozzle retaining nut
- **Optional:** Heater key (if installing a nozzle heater)

Refer to “Replacement Parts” on page 38 for component part numbers.

NOTE: The steps provided in this manual are based on a valve with a syringe barrel.

1. • Remove the protective covers.



2. • Install the nozzle.



3. • Secure the nozzle with the retaining nut.
 - **Optional:** To heat the fluid at the nozzle, go to “Install a Nozzle Heater (Optional)” on page 17. Return here to continue.

NOTE: The nozzle is only minimally secured by a nozzle heater. The nozzle is fully secured by the retaining nut.



4. (Syringe barrel installations only)

- By hand, thread the luer lock adapter loosely onto the fluid body, positioning it at a 15-degree angle from its end position.
- Tighten the nut with a wrench so that the adapter is parallel to the straight axis of the valve. Torque: 5 N•m (3.7 ft-lb) maximum
- **Optional:** Install a tube connector (for non-syringe barrel installations).

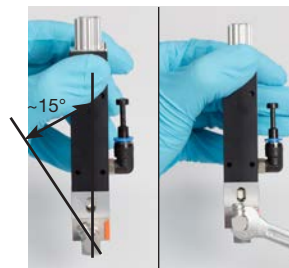

Continued on next page

Assemble the Valve (Initial Assembly) (continued)

5. (Syringe barrel installations only)

- Remove the safety plate.
- Position the syringe barrel bracket on the valve and reinstall the safety plate to secure it.



6. • (Syringe barrel installations only) Install the syringe barrel and syringe barrel adapter.



Install a Nozzle Heater (Optional)

Install the optional nozzle heater as shown in the illustration below. A nozzle heater controls the temperature of the material in the nozzle. The nozzle is secured minimally by the nozzle heater with an elastomer (heater O-ring) between it and the valve. The nozzle is fully secured by the retaining nut.

You will need the following items:

- Nozzle
- Nozzle heater
- Nozzle heater O-ring (NBR or EPDM)
- Retaining nut
- Heater key
- Heater cable

Refer to “Nozzle Heaters” on page 42 for component part numbers.

NOTES:

- The nozzle retaining nut predominantly secures and seals the nozzle in place. The heater remains in contact with the retaining nut through pressure supplied by a heater O-ring, which creates a partial space between the heater and the fluid body. This ensures thermal contact and allows the heater to rotate slightly even when the retaining nut is fully tightened.
- The image below is based on a Liquidyn P-Dot valve with a standard nozzle heater. The mounting process is the same for all valves.

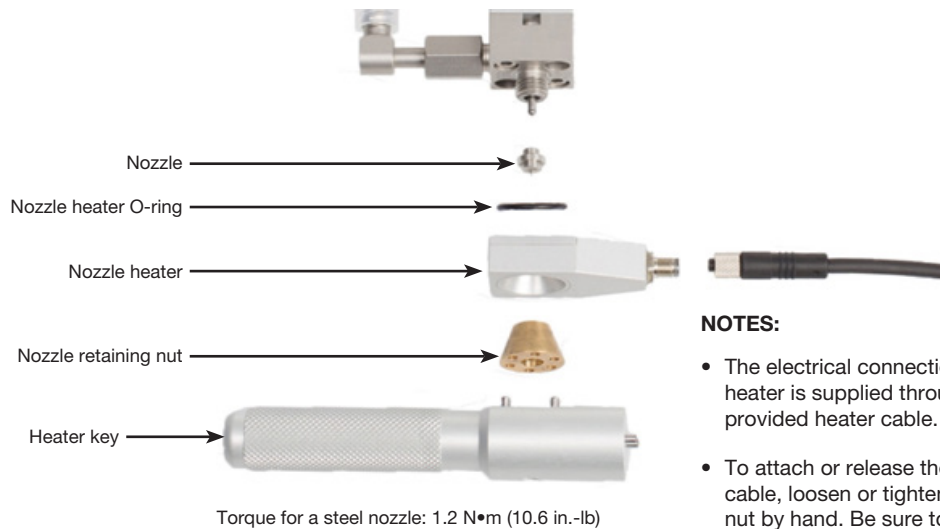

NOTES:

- The electrical connection for the heater is supplied through the provided heater cable.
- To attach or release the heater cable, loosen or tighten the knurled nut by hand. Be sure to connect the heater cable plug in the correct orientation.

Mount the Valve

Mount the valve using either of the following options.

Standard Mounting

Secure the valve using two M3 x 25 hex screws (customer-supplied).

Quick-Mounting

An optional quick-mounting bracket is available for faster valve removal and installation. Once the valve is installed using the quick-mounting components, it can be easily removed or installed using the quick-release fastener. Refer to “Quick-Release Valve Mounting Components” on page 41 for the quick-mounting kit part number.

You will need the following items:

- Vibration decoupler
- Quick-release fastener
- 2 M4 hex screws (minimum length: 10 mm)
- Hex wrench, size 2.5
- Hex wrench, size 3.0

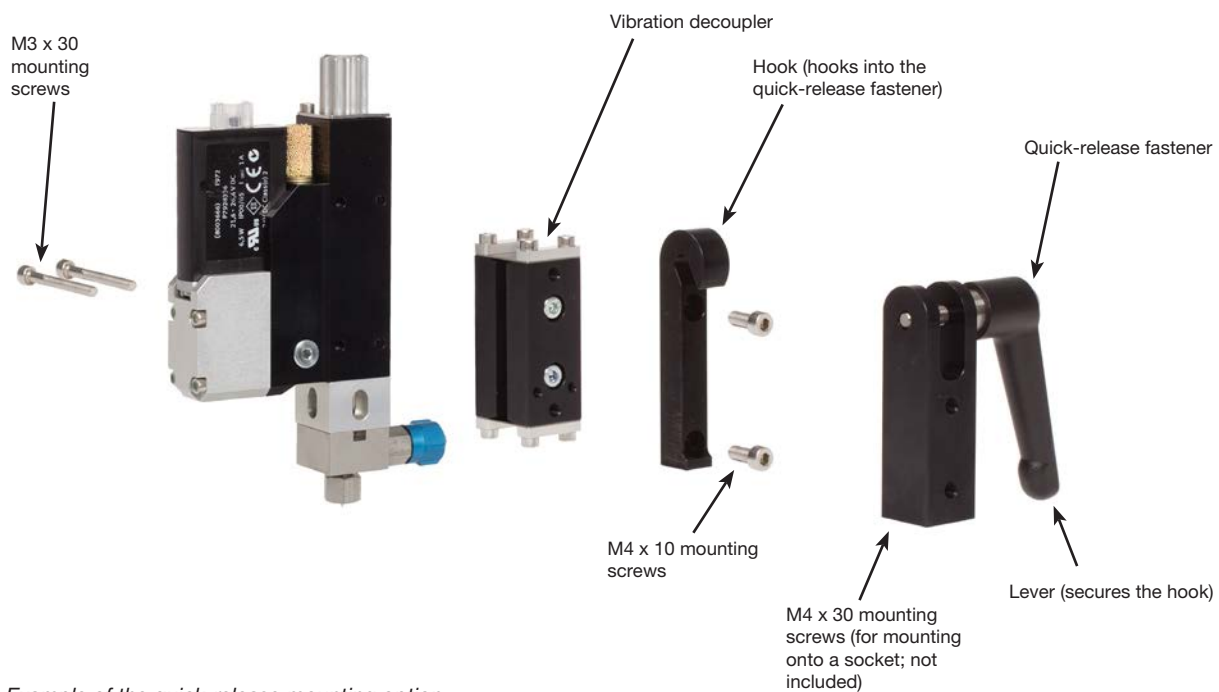
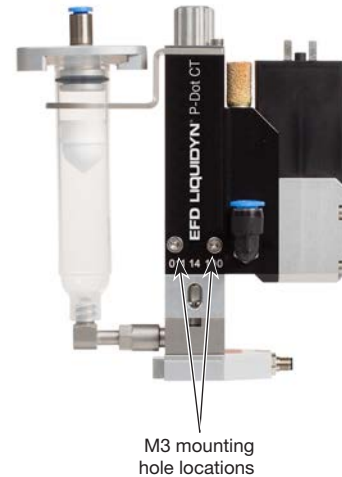

Connect Cables

Connect the M8 valve cable and other communication cables as applicable for your system to control the operation of the valve. The diagram below shows some typical system control setups.

NOTE: The valve is triggered by a square-wave signal (24 VDC). Because the pulse time is set to 2 ms, the opening time of the valve switches below 1 ms and automatically closes after each trigger signal. Most PLC systems make use of high performance transistor outputs which are suitable to control the valve directly. The valve is electrically connected to the control system via the supplied M8 valve cable.

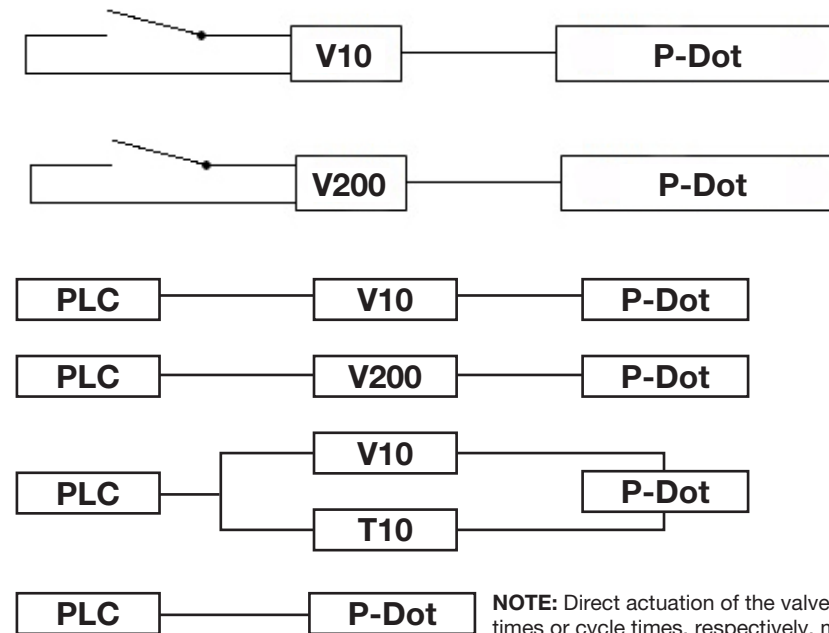

NOTE: Direct actuation of the valve via PLC is possible. However, the trigger times or cycle times, respectively, must be below 1 ms. For additional information, contact your Nordson EFD application specialist or the PLC manufacturer.

Key:

T10 = Liquidyn T10 or T20 heater controller

V10 = Liquidyn V10, V10M, V10D, or M10D controller

V200 = Liquidyn V200 controller

PLC = Higher-level controller

Connect the Air Supply

To achieve consistent dispensing results, the process parameters must be kept constant. The valve has two air pressure connections (operating pressure and fluid pressure) which must be continuously supplied with air pressure.

The level of pressure depends on the respective process. Each valve must be separately connected to a continuous air supply adjustable through a precision pressure regulator. To keep the operating pressure stable and constant, use a pneumatic accumulator (at least 0.4 liter volume).

For an air supply connection diagram, refer to “Installation Example” on page 21.

⚠ CAUTION

Ensure that the pressure limit values for the syringe barrel and air pressure tubing are not exceeded.

1. For the operating pressure, connect 6 mm OD tubing to the plug-in connector on the side of the valve.
2. For the fluid pressure, connect 4 mm or 6 mm tubing to the syringe barrel adapter (syringe barrel installations only).

NOTE: Nordson EFD recommends installing a precision pressure regulator with a maximum control tolerance of 0.2% and a pressure limit of 0–8 bar (0–116 psi).

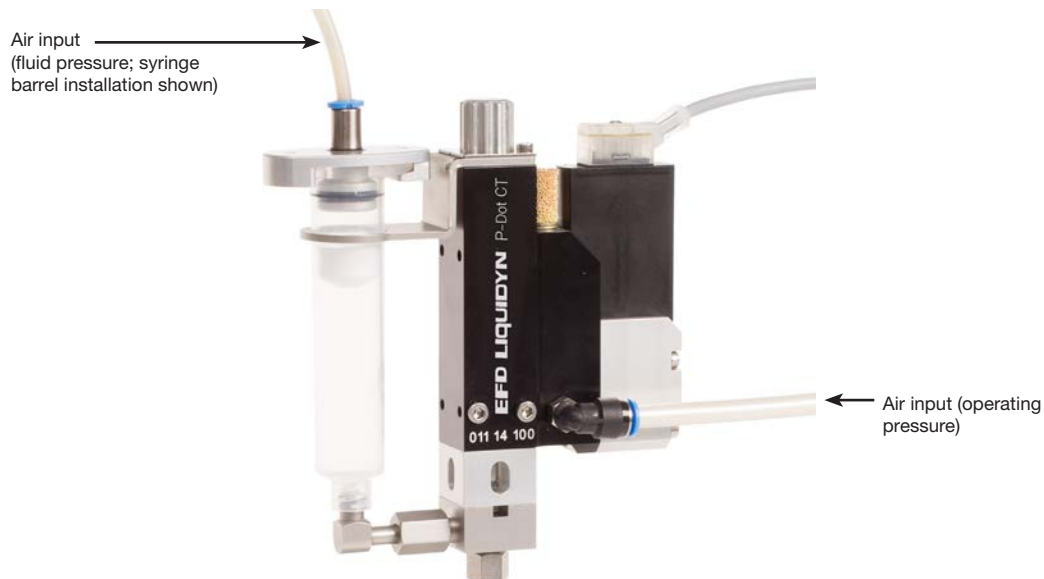

Installation Example

Item	Description
Pneumatic connections	<ul style="list-style-type: none"> Compressed air tube, 6 mm OD Dry, filtered air pressure, oil-free Filter grade: 40 µm Regulated by a precision pressure regulator Operating pressure limit: 3–8 bar (44–116 psi)
Fluid connection	<ul style="list-style-type: none"> Using a syringe barrel supply: Syringe barrel accessories with compressed 4 mm air tubing Using a tube supply: Tube connector with fluid tubing Fluid pressure limit: 100 bar (1450 psi)
Electrical connections	<ul style="list-style-type: none"> Supplied M8 valve cable from the valve to a valve controller or a higher-level controller, such as a PLC Power supply: 24 VDC Power consumption: 0.5 Amp (peak 5.0 Amp)
Optional	<ul style="list-style-type: none"> Nozzle heater (controlled by a temperature control unit) Process equipment (such as a laser light barrier for dot recognition or a cleaning station for nozzles)

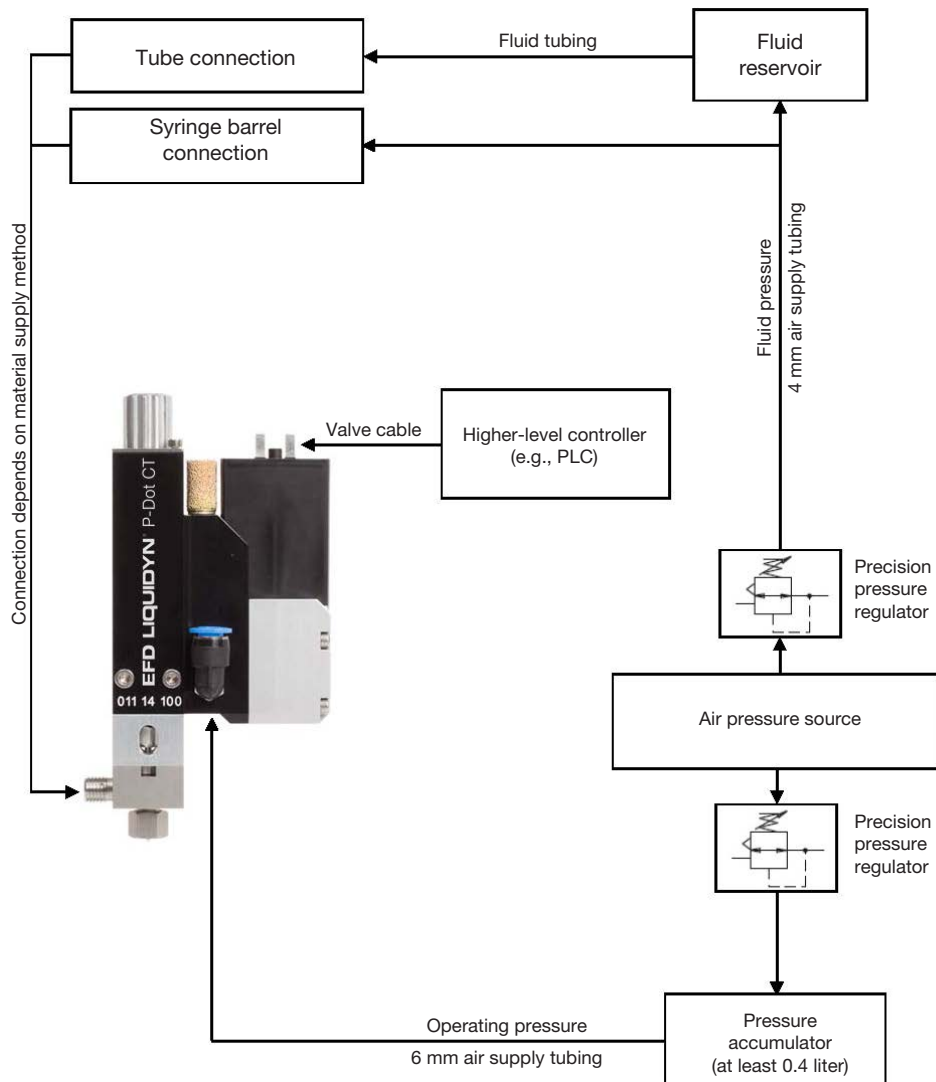

Liquidyn P-Dot valve connection diagram

Initial Startup

This section provides recommendations for system startup and operation. System startup for the valve depends on the control unit. If you are using a Nordson EFD Liquidyn controller, obtain the controller manual. If you are using higher-level controller, the control is set up by the customer.

CAUTION

Before switching on the system, ensure that all electrical and pneumatic connections are connected correctly and fully functioning.

1. Check electrical and pneumatic connections.
2. Switch on the control unit.
3. Turn on the air supplies.
4. Use the following actions to set up and test the valve operation using the control system manual or the customer-supplied control system and documentation. Refer to “Parameter Settings” on page 23 for information and recommendations on system setup.
 - a. Trigger the valve until the material to be dispensed leaves the nozzle opening. Place a collecting container or a paper sheet underneath the valve.
 - b. Clean the nozzle tip with a lint-free cloth.
 - c. Set the distance between the nozzle and the target (such as a sample product).
 - d. Initiate several dispense cycles to test the valve operation.
 - e. Evaluate the dispensing results and make adjustments until the desired dispensing performance is achieved. Refer to “Parameter Settings” on page 23 and to “Recommended Setup Adjustments” on page 24 for detailed information on system setup and adjustment.
5. To ensure optimal valve performance, maintain the system as described under “Service” on page 30.

Parameter Settings

The following table provides recommended settings for initial startup and testing of the valve operation. Detailed information on each parameter is shown after the table.

Parameter	Description	Recommendation
Pulse Time	The electrical trigger pulse of the valve.	2 ms only
Frequency	The number of tappet movements per second.	5Hz starting value
Fluid pressure	Sets the material supply to the valve for a consistent volume.	1.5 bar (22 psi) starting value
Operating pressure	Supplies the valve with energy for the tappet movement.	4 bar (58 psi) starting value
Tappet setting	The setting of the force screw, which changes the vertical movement of the tappet.	Do not adjust

Pulse Time

The Pulse Time corresponds to the electrical trigger pulse, or opening time, of the valve. The Pulse Time for the Liquidyn P-Dot valve must be 2 ms. With the P-Dot valve, Pulse Time adjustments do not affect the dispensing volume; instead, they can cause poor dispensing results.

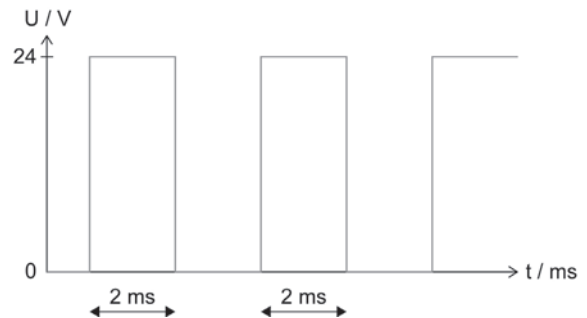

Frequency

Frequency is the number of tappet movements per second. A dispensing cycle consists of the Pulse Time and the pause time.

Physical Quantity	Formula	Unit
Frequency (f)	$f = 1 / T$	1Hz (hertz) = 1 / s
Dispensing cycle	$T = 1 / f$	1 s (second) = 1 / Hz

1 ms = 0.001 s (second)

Higher-level controllers may not allow you to enter the exact frequency. If such cases, frequency is set using the length of the pulse and the pause time.

EXAMPLE:

Because the pulse time must be 2 ms, set the pause time to 18 ms to achieve 50Hz.

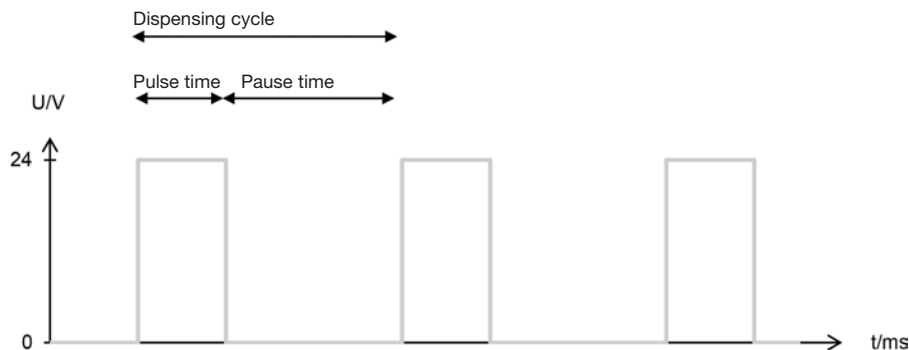

Parameter Settings (continued)

Fluid Pressure

The fluid pressure must be properly set to ensure that material is supplied at a consistent volume. Consider the following when setting the fluid pressure:

- The fluid pressure must stay within the tubing pressure specifications.
- Fluid supply tubing must be resistant to chemicals.
- The fluid pressure must be high enough for the material to exit the nozzle opening.
- The required fluid pressure will vary depending on the material, its viscosity, and the ambient temperature.
- Decreasing the fluid pressure too much may, in extreme cases, prevent proper deposit separation from the nozzle.
- Prevent pressure fluctuations. Note that pressure loss due to friction occurs as material flows through the material delivery components.

Recommended Setup Adjustments

The following table provides recommended adjustments to help you quickly find optimum system settings for your application. Because of the diversity of materials that can be dispensed, the effectiveness of these recommendations can vary, but they serve to share our experience with you.

Goal	Operating Pressure	Tappet Adjustment	Fluid Pressure	Heater (Temperature)	Nozzle Orifice Diameter
Smaller dots	Down	Down	Down	Down	Down
Bigger dots	Up	Up	Up	Up	Up
Prevent satellites	Down	Up	Down	Down	Up
Prevent residue at the nozzle	Up	Down	Down	Up	Not applicable

Key:
 Down = lower operating pressure or temperature / tighten screw / smaller diameter
 Up = greater operating pressure or temperature / loosen screw / larger diameter

Recommended Action for Preventing Satellite Drop Formation

Simultaneously adjust the operating pressure and the force screw as shown below.

Goal	Operating Pressure	Force Screw
Prevent satellites	Decrease by 0.1 bar (1.5 psi)	Loosen by 0.1 turn (counterclockwise as viewed from above)

Recommended Action for Preventing Residue Buildup at the Nozzle

Simultaneously adjust the operating pressure and the force screw as shown below.

Goal	Operating Pressure	Force Screw
Prevent residue at the nozzle	Increase by 0.1 bar (1.5 psi)	Tighten by 0.1 turn (counterclockwise as viewed from above)

Tappet Adjustment

The setting of the force screw affects the vertical movement of the tappet. The screw is factory-preset.

NOTES:

- An improper setting can cause the valve to stop dispensing.
- To return a force screw to the factory setting, refer to “Returning the Force Screw to the Factory Setting” on page 27.
- To set all valves in a multi-valve system to the same force screw setting (required for deposit integrity), refer to “Manually Setting the Force Screw for Multiple Valves” on page 28.

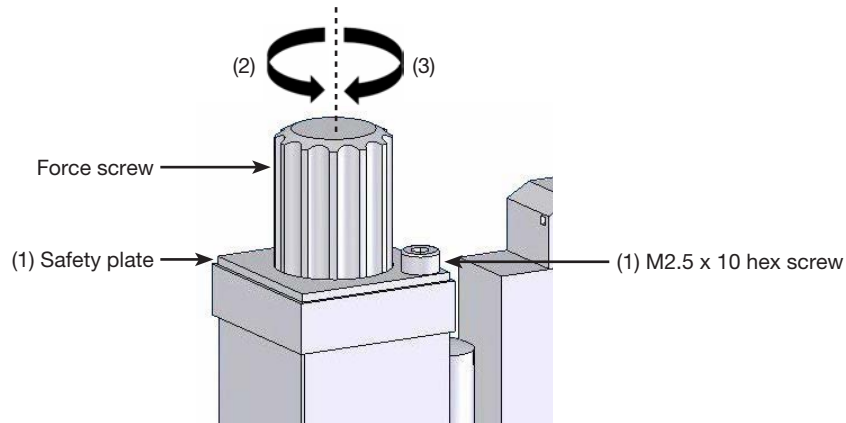

Adjusting the Force Screw

1. Use a 2.5 mm hex wrench to remove the safety plate (1).
2. Adjust the force screw. Refer to the following table for settings.

Settings

Loosen (2) <i>counterclockwise, as viewed from above</i>	<ul style="list-style-type: none"> • Reduces the force of the tappet movement. • Prevents the formation of satellites. • Slightly increases the dispensing volume.
Tighten (3) <i>clockwise, as viewed from above</i>	<ul style="list-style-type: none"> • Increases the force of the tappet movement. • Improves deposit cut-off. • Slightly decreases the dispensing volume.

NOTE: The two end positions of the force screw are extreme positions:

- Fully open decreases the force to fullest extent possible.
- Fully closed stops deposit formation.

In between these two extreme positions is the optimum setting, which should be determined one time only using these instructions.

Tappet Adjustment (continued)

Force Screw Setting Units

The force screw setting is indicated by clicks or turns.

- 12 clicks = 1 turn

Special Tools for Tappet Adjustment

NOTE: Refer to “Tools and Supplies” on page 44 for tool part numbers.



The scale head tool allows you to easily replicate force screw settings for multiple valves.



The tappet measuring system tool allows you to easily determine the current tappet setting and to very precisely replicate the setting for multiple valves.

Tappet Adjustment Methods

If you use several valves with the same parameters, the following methods can help you ensure that all valves have the same tappet setting.

Manual	<ul style="list-style-type: none"> • No additional accessories required. • Takes the most time. <p>Refer to “Manually Setting the Force Screw for Multiple Valves” on page 28.</p>
Scale head tool	<ul style="list-style-type: none"> • Easy adjustment. • Economical.
Tappet measuring system tool	<ul style="list-style-type: none"> • Accuracy of 1/100 (1 to 100). • Purpose-built for this task.

Tappet Adjustment (continued)

Returning the Force Screw to the Factory Setting

You will need the following items:

- Open-end wrench, size 10 mm
- Hex wrench, size 2 mm
- **Optional:** Heater key

- Disconnect all cables and tubing from the valve.
 - Remove the valve from the machine.
 - Remove the safety plate.
 - Remove the retaining nut (or heater element) from the valve.

NOTE: If a nozzle heater is installed, use the heater key to remove the retaining nut.

NOTE: The nozzle is held by the retaining nut, so be careful not to lose the nozzle.

- Set the zero position of the nozzle:
 - Put the nozzle on the tip of the tappet and push gently with your finger against the nozzle.
 - Between the nozzle and the fluid body thread should now be a gap ("x"). If no gap occurs, tighten the force screw until a gap occurs.

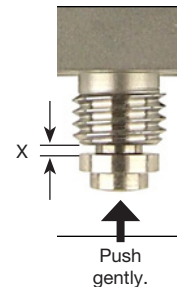

- Loosen the force screw while pushing against the nozzle until the nozzle touches the front of the fluid thread. The zero position is now obtained.

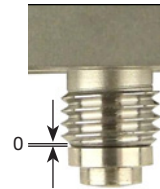

- Tighten the force screw (from the zero position) 0.5–0.75 turns clockwise as viewed from above.
- Reassemble the safety plate and the retaining nut (or heater element) and reinstall the valve.

Tappet Adjustment (continued)

Manually Setting the Force Screw for Multiple Valves

You will need the following items:

- Open-end wrench, size 10 mm
- Hex wrench, size 2 mm
- **Optional:** Heater key

If your application requires that several valves in a multi-valve system produce the same dispensing results, all dispensing parameters (fluid pressure, operating pressure, tappet setting, and, if applicable, temperature) must be set to the same values.

The fluid pressure, operating pressure, and temperature (if applicable) can easily be set with the Liquidyn V200 controller. However, the tappet setting varies from valve to valve due to unavoidable part tolerances. The best way to set the tappet is to use the scale head tool, which allows you to make the tappet setting the same for every valve. You can also manually set the tappet using this procedure.

Before manually setting the tappet on all the valves, you must determine the tappet setting of the valve with which the desired dispensing results have been achieved.

NOTE: Refer to “Tools and Supplies” on page 44 for the scale head and measuring system tool part numbers.

-
1.
 - Disconnect all cables and tubing from the valve.
 - Remove the valve from the machine.
 - Remove the safety plate.

-
2.
 - Mark the position of the set screw.

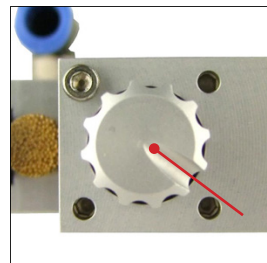

-
3.
 - Remove the retaining nut (or heater element) from the valve.

NOTE: If a nozzle heater is installed, use the heater key to remove the retaining nut.

NOTE: The nozzle is held by the retaining nut, so be careful not to lose the nozzle.

-
4. Set the zero position of the nozzle:
 - Put the nozzle on the tip of the tappet and push gently with your finger against the nozzle.
 - Between the nozzle and the fluid body thread should now be a gap (“x”). If no gap occurs, tighten the force screw until a gap occurs.

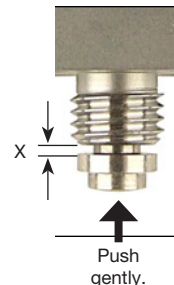

Continued on next page

Tappet Adjustment (continued)

Manually Setting the Force Screw for Multiple Valves (continued)

-
5. • Loosen the force screw while pushing against the nozzle until the nozzle touches the front of the fluid thread. The zero position is now obtained.

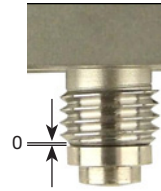

-
6. • Determine how many turns / clicks the knob was moved from the marked position (step 2) and memorize the number.

In this example: 5/8 turns or 7.5 clicks.

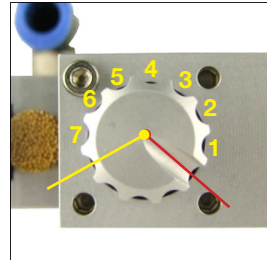

-
7. • Tighten the force screw the identified number of turns / clicks until you reach the marked position.
-
8. • Reassemble the safety plate and the retaining nut (or heater element) and reinstall the valve.
-
9. • Repeat the identified number of turns / clicks for all valves.

NOTE: Always set the zero position of the nozzle first before tightening the set screw the identified number of turns / clicks.

Service

Regularly perform maintenance on your micro-dispensing valve. Regular maintenance will save you cost-intensive repairs and is a requirement for long valve lifespan. Nordson EFD valves are designed to be maintained easily. All the material-carrying parts can be removed, cleaned, and maintained by the customer.

NOTE: Customers should service only the material-carrying components. For any service not related to the material-carrying components, contact your Nordson EFD support representative.

Recommended Maintenance Schedule

Cleaning and maintenance intervals vary based your operating conditions (dispensing frequency, frequency of use, dispensing material, etc.). The following table provides recommendations only.

Variable	Perform Weekly Valve Cleaning	Perform Daily Valve Cleaning (or at the end of the pot life)
Dispensing frequency	Less than 20Hz	Greater than 20Hz
Dispensing material	<ul style="list-style-type: none"> • Oil • Grease • UV glue 	<ul style="list-style-type: none"> • Dispersions • Reactive adhesives • Epoxies

NOTE: The sealing effectiveness of the tappet O-rings can be compromised if the replacement intervals are too long (causing worn or damaged O-rings). Worn or damaged O-rings can cause dispensing material to enter the drive system, thus compromising valve operation.

Valve Cleaning

You will need the following items:

- Protective clothing
- Open-end wrench, size 10 mm
- Hex wrench, size 2 mm
- Toothpick
- Cleaning material
- Container
- Compressed air
- Lint-free cloth
- **Optional:** Ultrasonic bath
- **Optional:** Microscope

WARNING

- Before any component change or service activity, relieve air pressure from the fluid reservoirs and switch off heater control (if applicable).
- Disconnect the system from the power supply before beginning work on electrical or electronic system components or opening the switchgear cabinet.
- Disconnect the mains power plug to isolate the system from the power supply. Check for safe isolation from the power supply using suitable measuring instruments. Only perform maintenance work on a system that is safely isolated from the power supply.
- Wear appropriate personal protective equipment, including, but not limited to, gloves, safety goggles, and breathing protection.
- Switch off the compressed air supply before disconnecting the system from the pneumatic connections.
- Read and understand the SDS for the dispensing material and the risk of the associated health hazards so that suitable safety measures can be taken for the correct handling of the dispensing material.

Service (continued)

Shut Down the System

1. Shut off the air supply.
2. Switch off the power of every control unit, then switch off power to the valve.
3. Disconnect all tubing and cables.
4. Disconnect the material supply.
5. Continue with the procedures in this section to disassemble and clean the valve.

Disassemble the Valve

⚠ CAUTION

Do not open the color-sealed screws. Unauthorized modifications or the breaking of the sealed screws voids the warranty and guarantee.

1.
 - (Syringe barrel installations only) Remove the syringe barrel from the valve.



2.
 - (Syringe barrel installations only) Disconnect the luer lock adapter from the fluid body.
 - **Optional:** Remove the tube connector.



3.
 - Unscrew the nozzle retaining nut.
 - **Optional:** If you are using a heater, use the heater key to remove the nozzle retaining nut.



4.
 - Remove the nozzle from the fluid body.



Continued on next page

Service (continued)

Disassemble the Valve (continued)

-
- 5.
- Unscrew and remove the four screws that secure the fluid body.
 - Carefully remove the fluid body without damaging the tappet.

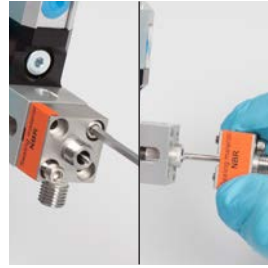

-
- 6.
- Use a toothpick to remove the O-ring from the fluid body.

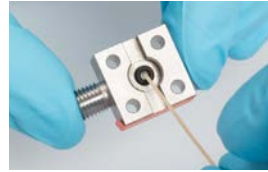

-
- 7.
- Remove the second O-ring from the tappet.
 - Clean the tappet and annulus with lint-free paper.



-
- 8.
- Unscrew and remove the two screws that secure the drainage block.
 - Carefully remove the drainage block without damaging the tappet.



Service (continued)

Clean the Valve Components

⚠ CAUTION

Never use solvents or cleaning agents that contain halogenated hydrocarbons (such as trichlorethane, methyl chloride, or dichloromethane). Halogenated hydrocarbons can dissociate, causing an explosion upon contact with aluminum and galvanized surfaces. Before using a solvent or cleaning agent, check its ingredients.

- Submerge all the components in a container filled with cleaning fluid.
 - After 3–5 minutes, remove the components from the container and clean them with a lint-free cloth.

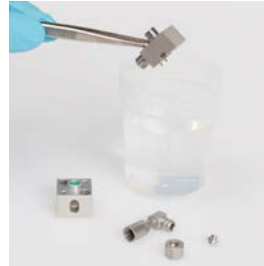

⚠ CAUTION

Do not damage the holes on the sealing faces of the material carrying components.

- Optional:** Use an ultrasonic bath to clean the components.

- Use the pipe cleaners from the cleaning kit to clean the disassembled components (luer lock adapter, nozzle retaining nut, nozzle, fluid body, and the tappet if needed).

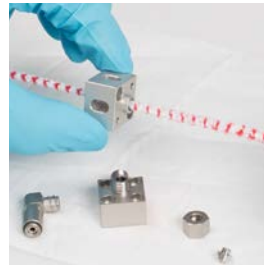

- Use compressed air to clear any remaining cleaning fluid from the parts.

⚠ CAUTION

Do not damage the holes on the sealing faces of the material carrying components.

- Examine the cleaned components for any remaining residue (especially the nozzle, which should be examined under a microscope).
- If the parts are still contaminated, repeat the cleaning process.



Service (continued)

Assemble the Valve (After Cleaning)

Follow this procedure to assemble a valve after cleaning it. You will need the following items:

- Hex wrench, size 10
- Hex wrench, size 2.5
- Nozzle
- Nozzle retaining nut
- O-rings and barrier grease
- Wooden pick
- **Optional:** Heater key (if installing a nozzle heater)

NOTE: The steps provided in this manual are based on a valve with a syringe barrel.

- Position the drainage block on the valve body in the correct orientation.

CAUTION

Do not subject the valve tappet to lateral, or sideways, force.

- Secure the drainage block with the two screws removed previously.
- Ensure that the screw heads disappear within the screw holes.

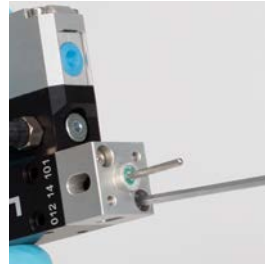

- Using a wooden pick, apply a small amount of barrier grease (Barriereta L55/2) at the base of the tappet and distribute this around the annulus.

NOTE: When dispensing instant adhesive (cyanoacrylates), Nordson EFD recommends petroleum jelly for use as the barrier grease. Contact Nordson EFD for assistance in dispensing cyanoacrylates.

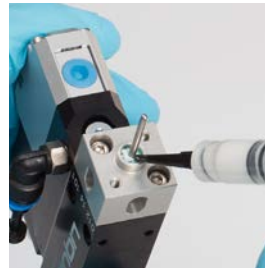

- Install a new O-ring (standard material: NBR) on the tappet and press the O-ring down into the greased annulus.
 - Distribute the grease evenly so that the entire sealing surface of the O-ring is covered.
 - Install the second new (grease-free) O-ring on the tappet on top of the initial O-ring.

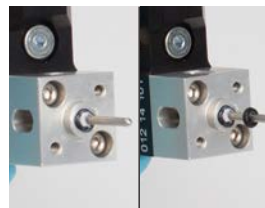

- Mount the fluid body precisely over the tappet without tilting it.



Continued on next page

Service (continued)

Assemble the Valve (After Cleaning) (continued)

5. • Tighten the fluid body screws (2x) crosswise.
Torque: 0.8 N•m (5.9 ft-lb) maximum



6. • Install the nozzle.



7. • Secure the nozzle with the retaining nut.
NOTE: The nozzle is only minimally secured by a nozzle heater. The nozzle is fully secured by the retaining nut.



8. (Syringe barrel installations only)
- By hand, thread the luer lock adapter loosely onto the fluid body.
 - Position the luer lock adapter at a 15-degree angle to its end position and then tighten the nut with a wrench so that the adapter is level with the straight axis of the valve. Torque: 5 N•m (3.7 ft-lb) maximum
 - **Optional:** Install the tube connector.

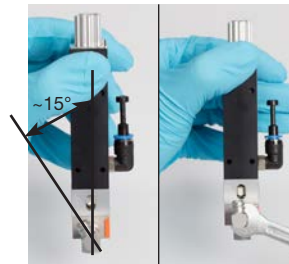

9. • (Syringe barrel installations only) Install the syringe barrel and syringe barrel adapter.
• Mount the valve and restore the system to normal operation.



Service (continued)

Tappet Replacement

Follow this procedure to replace the tappet. You will need the following items:

- Replacement tappet
- Barrier grease
- Open-end wrench, size 3 mm (supplied)
- Open-end wrench, size 6 mm (supplied)

1. • Go to “Disassemble the Valve” on page 31 and perform all the steps to disassemble the valve. Return here to continue.

2. • Remove the tappet from the housing by pulling the tappet retaining nut just enough to allow you to position a 3.5 mm open-end wrench on the piston rod.



3. • Hold the piston rod in place with the 3.5 mm open-end wrench and loosen the retaining nut with the 6 mm open-end wrench by turning it counterclockwise.



4. • Remove the retaining nut (including the tappet) by hand.



5. • Insert the new / cleaned tappet in the retaining nut.



6. • If the valve is used to dispense adhesives, apply a small amount of barrier grease to the piston rod threads to prevent the retaining nut from adhering to the piston rod during dispensing.
- Screw the retaining nut and tappet into the piston rod by hand.



NOTE: When turning the piston rod, ensure that the tappet is centrally aligned.

Continued on next page

Service (continued)

Tappet Replacement (continued)

-
7. • Hold the piston rod in place with the 3.5 mm open-end wrench and secure the retaining nut with the 6 mm open-end wrench by turning it clockwise.
Torque: 0.4–0.6 N•m (3.5–5.3 in.-lb).



-
8. • Refer to “Assemble the Valve (After Cleaning)” on page 34 to reassemble the valve, then reinstall the valve and restore the system to normal operation.







Part Number

Part #	Description	
7825002	Liquidyn P-Dot CT actuator	Suitable for medium- to high-viscosity fluids with cycle rates of up to 150Hz

Replacement Parts

Valve Components



Refer to “Operating Features” on page 13 for the location of these components in the valve.

Part #	Description	Material	Item
7825033*	Tappet, P-Dot, 27L x 2.0D mm	Steel	
7825034	Tappet nut, P-Dot	Steel	
7826092* (5 pack) 7826093* (50 pack)	O-ring, 2 x 1.5 mm (between the tappet and fluid body)	NBR	
7826080 (5 pack) 7826081 (50 pack)		EPDM	
7826082 (5 pack) 7826083 (50 pack)		Perlast	
7826084 (5 pack) 7826085 (50 pack)		Viton	
7825037*	Steel fluid body	303 stainless steel	
7825008	Drainage block	303 stainless steel	
7825182	2.5 m (8.2 ft) M8 valve cable	n/a	
7825011	Safety plate	n/a	

*Other selections are available. Contact your Nordson EFD application specialist for assistance.



Replacement Parts (continued)

Nozzles and Nozzle Retaining Nuts

Nozzle Type	Part #	Description	Material	Item
Flat	7825063*	Steel flat nozzle, 150 µm	303 stainless steel	
Needle	7825075*	Steel needle nozzle, 150 µm	303 stainless steel	

*Many nozzle types and sizes are available. Contact your Nordson EFD application specialist for assistance.

The retaining nut secures the nozzle to the valve. The choice of retaining nut depends on the type of nozzle and whether or not a nozzle heater is installed. Contact your Nordson EFD application specialist for assistance.

Nozzle Type	Part #	Description	Material	Compatibility	Item
Without heater	7825042*	Hexagon retaining nut	Stainless steel	For all flat nozzles and steel-needle nozzles	
With heater	7825051*	Stainless-steel retaining nut	Stainless steel	For the standard nozzle heater (compatible with all nozzle types)	
	7825047*	Stainless-steel retaining nut	Stainless steel	For the small nozzle heater (compatible with all nozzle types)	

*Other selections are available. Contact your Nordson EFD application specialist for assistance.

Replacement Parts (continued)

Syringe Barrels and Accessories

Many syringe barrel sizes and accessories are available. Contact your Nordson EFD application specialist for assistance. For a complete list of Optimum components, see www.nordsonefd.com/Optimum.

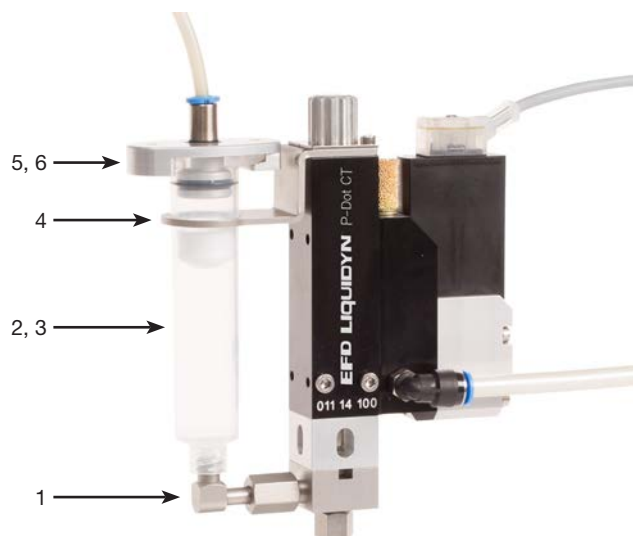

Item	Description	Configuration Options
1	Luer lock adapter for 3cc to 70cc syringe barrels	<ul style="list-style-type: none"> • Steel
2	Syringe barrel	<ul style="list-style-type: none"> • Normal • Light-proof • UV-blocker
3	Piston	<ul style="list-style-type: none"> • Normal • UV-blocker
4	Syringe barrel holder	
5	Syringe barrel adapter for 4 mm OD tube connection	<ul style="list-style-type: none"> • Aluminum
6	O-ring (NBR) for syringe barrel adapter	

Typical Luer Lock Fitting

Part #	Description	Material	Item
7825120*	Steel luer lock adapter for syringe barrels	Stainless steel	

*Other selections are available. Contact your Nordson EFD application specialist for assistance.

Replacement Parts (continued)

Material Supply Tubing Components

The following material supply tubing and connectors are available from Nordson EFD. Additional selections may be available. Contact your Nordson EFD application specialist for assistance.

Steel Tubing Connectors

Part #	Description	Material	Item
7825137	4 mm OD tubing connector	Stainless steel / aluminum	
7825138	6 mm OD tubing connector		
7825139	8 mm OD tubing connector		



Tubing

Part #	Description	Material
7826072	3.2 mm (1/8") PTFE tubing, 5 m (16.4 ft)	PTFE
7826074	4 mm OD / 2.6 mm ID PTFE tubing, 5 m (16.4 ft)	PTFE
7826075	6 mm OD / 4 mm ID PTFE tubing, 5 m (16.4 ft)	PTFE
7826076	4 mm OD compressed air tubing, 5 m (16.4 ft)	Polyurethane (PU)
7826077	6 mm OD compressed air tubing, 5 m (16.4 ft)	Polyurethane (PU)

Accessories

Quick-Release Valve Mounting Components

When a valve is installed using these components, it can be quickly and easily removed and reinstalled. Refer to "Quick-Mounting" on page 18 for installation instructions.

Part #	Description	Item
7825018	Vibration decoupler	
7825020	Quick-release fastener	
—	Two (2) M4 hex screws (minimum length: 10 mm)	Customer supplied

Precision Pressure Regulator

Nordson EFD recommends a dry, oil-free, filtered air supply (40 µm filter grade).

Part #	Description
7825268	Precision pressure regulator

Accessories (continued)

Nozzle Heaters

Many materials can easily be dispensed without preheating. However, it is often advisable to preheat highly viscous materials just before application to lower the viscosity. Doing so can prevent variations in viscosity. The use of a nozzle heater guarantees a constant temperature of the material to be dispensed at the nozzle. Contact your Nordson EFD application specialist for assistance.

A nozzle heater can be installed on the valve in place of the retaining nut. The heater can be controlled using a separate temperature controller (such as the Liquidyn T10) or by the Liquidyn V200 controller.

NOTES:

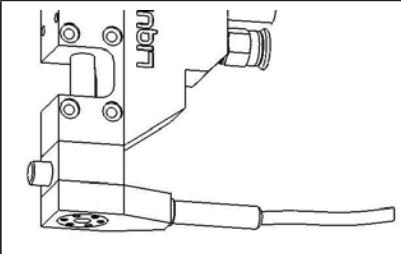
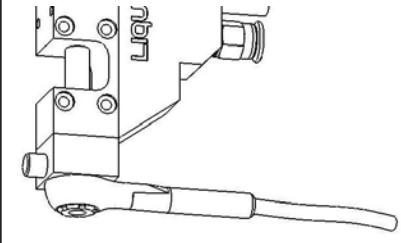

- Nozzle heater O-rings are available in NBR or EPDM. Refer to “Nozzle Heater O-Rings” on page 43 for part numbers.
- A special heater key is required for installation. Refer to “Heater Key” on page 43 for the part number.
- A nozzle retaining nut suitable for either a standard or small nozzle heater is required. Refer to “Nozzles and Nozzle Retaining Nuts” on page 39 for nozzle heater retaining nut part numbers.

Heater Type	Heating Capability	Nozzle Heater
Standard	Up to 90° C (194° F)	
Small (a small heater has a low-profile height and is less thick overall)	Up to 90° C (194° F)	

Accessories (continued)

Nozzle Heater Kits

NOTE: These nozzle heaters include a flange suitable for mounting the Laser Light Barrier. Refer to “Nozzle Heater Cables” for suitable cables.

Part #	Description	Material	Item
7825155	Nozzle heater kit, small, M5, 90-degree plug	n/a	The kit includes the heater element, retaining nut, plug, O-ring, and heater key.
7825149	Nozzle heater kit, standard, M5, straight plug	n/a	
7825150	Nozzle heater kit, standard, M5, 90-degree plug	n/a	
7825153	Nozzle heater element, small, M5	Aluminum	
7825148	Nozzle heater element, standard, M5	Aluminum	
7825152	Nozzle heater element, standard, M8	Aluminum	
7825157	Nozzle heater element, large, M5 NOTE: This larger heater element heats the material farther up into the supply tubing, allowing more fluid to be heated before it is dispensed.	Aluminum	

Nozzle Heater Cables

Part #	Description	
7825182	2.5 m (8.2 ft) M8 valve cable	
7825183	0.5 m (1.6 ft) M8 valve cable	
7825176	3 m (10 ft) M5 valve cable, straight plug	
7825177	3 m (10 ft) M5 valve cable, 90-degree plug	

Nozzle Heater O-Rings

Two types of nozzle heater O-ring are available.

Part #	Description	Material
7826088 (pack of 5) 7826089 (pack of 50)	NBR nozzle heater O-ring, 13 x 1.5 mm	NBR
7825235	EPDM nozzle heater O-ring, 13 x 1.5 mm	EPDM







Heater Key

The heater key is required to install the heater retaining nuts.

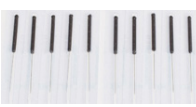
Part #	Description	Item
7825209	Heater key	

Accessories (continued)

Tools and Supplies

Item	Part #	Size / Material	Description
	7825262	1.5 g	Barrier grease for O-rings
	7825263	5.0 g	
	7825205	0.12 mm	Nozzle cleaning probes
	7825206	0.16 mm	
	7825207	0.2 mm	
	7825208	0.25 mm	
	7825210	n/a	Nozzle pinch tools
	7825192	NBR	Standard cleaning kit (order based on O-ring type)
	7825191	EPDM	
	7825194	Perlast	
	7825196	Viton	
	7825198	EPDM	Expanded cleaning kit (order based on O-ring type)
	7825195	Perlast	
	7825197	Viton	
	7825012	n/a	Scale head tool for tappet force screw setting
	7825215	n/a	Measuring system tool for tappet force screw setting

Technical Data

Dimensions

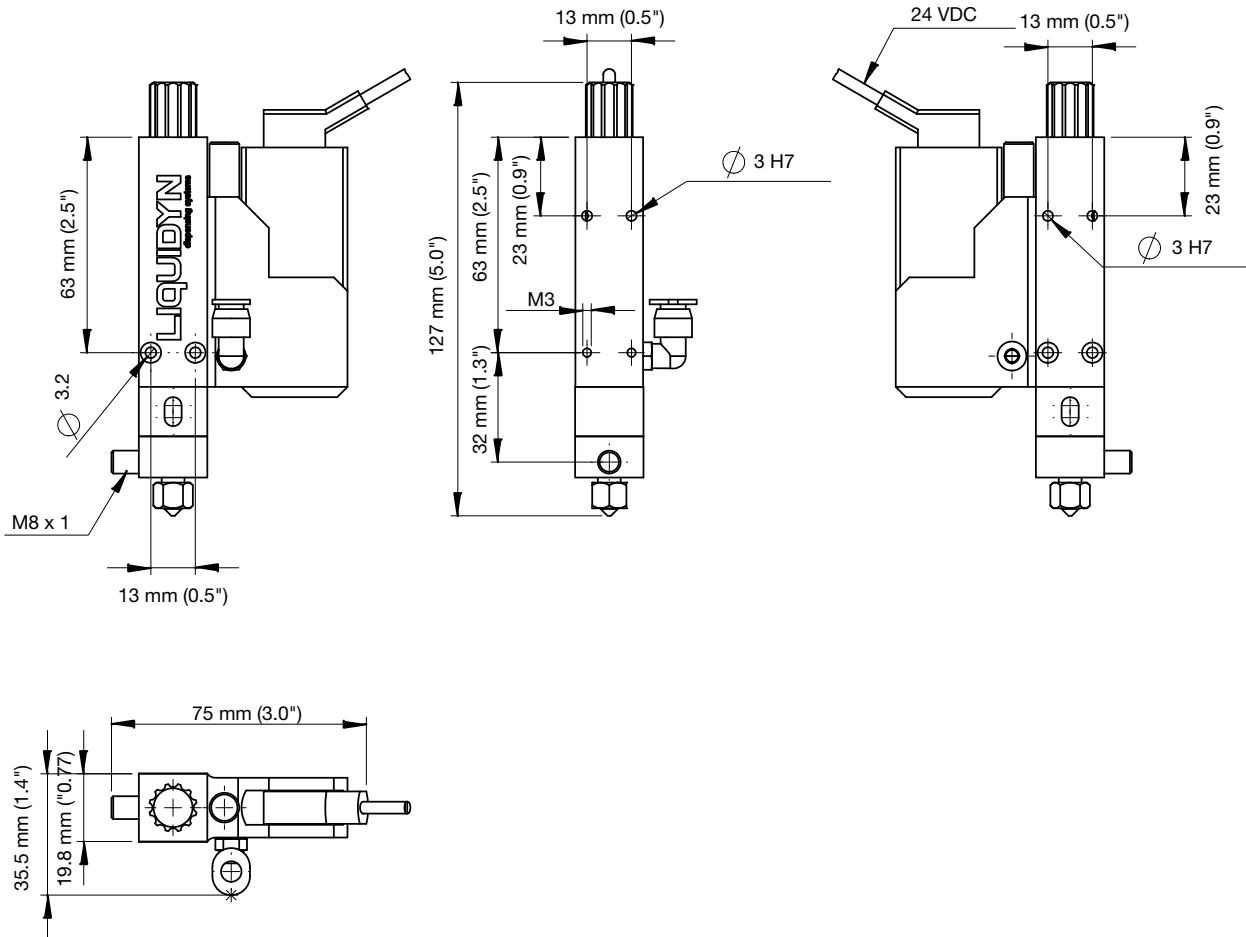

M8 Valve Cable Pin Positions

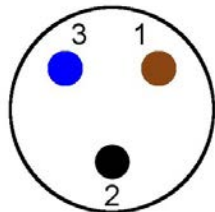

Pin	Color	Function
1	Brown	None
2	Black	Valve (+)
3	Blue	Valve (-)

Appendix A, About Non-Contact Dispensing

The way a micro-dispensing valve system works for the non-contact dispensing of micro-deposits of fluid is comparable to the way an ink-jet system works. In both systems, a jetted deposit with a spherical head and a thin thread (shaped much like a tadpole) is formed. The dimensions vary depending on the material being dispensed, the process, and the valve settings.

As the deposit is squeezed (or jetted) out of the nozzle opening, the thin thread constricts because of the absence of further fluid supply, the surface tension, and also the continual movement of the deposit, until the deposit finally separates from the nozzle opening. The thread extending from the deposit's spherical head is either absorbed by the head or separated into at least one more (sometimes many more) smaller head. This depends on the rheological properties of the fluid. At low airflows or in asymmetrical drop-off conditions, a smaller head can land on the substrate next to the main head, creating satellite drops. The thin thread formed at the nozzle output retracts back into the nozzle due to the surface tension and remains at the nozzle output. This residue at the nozzle output can have a negative influence on the dispensing properties of the valve.

The formation of satellite drops and / or nozzle contamination can be reduced or eliminated by using the correct dispensing settings.

Low Viscosity Materials

Try the following to reduce or eliminate the formation of satellite drops: Reduce the pressure supplied to the material by reducing both the fluid pressure and the operating pressure and also by adjusting the tappet. Refer to "Tappet Adjustment" on page 25.

NOTE: With low viscosity materials, nozzle contamination is usually a minor issue because the subsequent drop removes the residue at the nozzle output.

High Viscosity Materials

With high viscosity materials, the thin thread that retracts back into the nozzle and the resulting nozzle contamination can negatively affect the dispensing process. Try the following to reduce or eliminate nozzle contamination:

- Increase the amount of supplied force. The amount of force depends on the operating pressure and the pretension of the valve tappet. Increasing the amount of force can have a positive effect on the drop-off properties of the deposit and thus improve process reliability. Refer to "Tappet Adjustment" on page 25.
- Warm the material being dispensed to reduce the viscosity. This is particularly effective for highly viscous materials. In most cases, the dispensing process reliability of highly viscous materials improves with decreased viscosity. Material warming can be accomplished by installing a nozzle heater. Refer to "Install a Nozzle Heater (Optional)" on page 17.

NOTE: In general, viscosity halves per 10 Kelvin temperature unit increase. Exceptions are silicone oils and greases, although elevating the temperature of these materials can lead to improvement.

Deposit Size

The dispensed volume of a deposit depends on the following parameters:

- Cross section of the valve
- Operating pressure
- Fluid pressure
- Position of the force screw.

The smallest possible deposit size is subject to physical limitations. The smaller the deposit, the higher the surface tension in relation to its mass. Thus, the amount of required energy needed for the launch of a deposit raises significantly in relation to its mass. At a certain point, it is physically impossible to transfer the required energy to the dispensed material any longer, particularly in the dispensing of highly viscous materials.

Appendix B, P-Dot Valve Interface Overview

The Liquidyn P-Dot pneumatic micro-dispensing jet valve is designed for the non-contact dispensing of low- to medium-viscosity materials, including oils, greases, glues, flux, and filled products. The valve can be operated using a Nordson EFD Liquidyn valve controller or directly by the customer via a 24V input using a customer-supplied controller or a programmable logic controller (PLC).

Electrical Control

The valve is triggered by a square-wave signal (24 VDC). Because the pulse time is set to 2 ms, the opening time of the valve switches below 1 ms and automatically closes after each trigger signal. Most PLC systems make use of high performance transistor outputs which are suitable to control the valve directly. The valve is electrically connected to the control system via the supplied M8 valve cable.

NOTE: To continuously dispense the exact amount with every shot, the Pulse Time must be 2 ms ($\pm 5\%$). Observe the cycle time of the PLC; if necessary, check the signal with an oscilloscope.

Electrical Specifications

Item	Specification
Maximum operating frequency	150Hz
Pulse Time	2 ms
Input voltage	24 VDC, PLC compatible
Power consumption	0.5 Amp (peak 5.0 Amp)

Oscillogram (Valve Output) for a Liquidyn P-Dot Valve

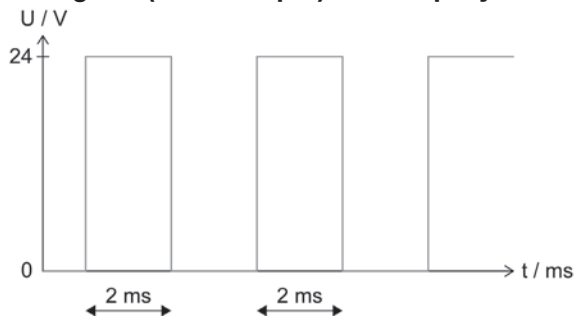

M8 Valve Cable Pin Positions

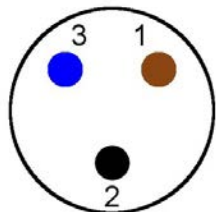

Pin	Color	Function
1	Brown	None
2	Black	Valve (+)
3	Blue	Valve (-)

Appendix B, P-Dot Valve Interface Overview (continued)

Optional Nozzle Heater Control

A nozzle heater can be installed on the valve in place of the retaining nut. The heater can be controlled using a separate temperature controller (such as the Liquidyn T10) or by the Liquidyn V200 controller.

To use another method for controlling the heater, the following information applies:

- The heater comprises a heating coil and a 100-ohm platinum (PT100) resistance temperature detector (RTD).
- The heater can be triggered by most control units.
- Heater power consumption is approximately 1.3 Amps, with 24 VDC used during the heating process.

NOTE: The maximum heater temperature is 90° C (194° F). For consistent dispensing results, keep the control deviation to a minimum (lower than 3%).

Nozzle Heater Specifications

Item	Specification
Input voltage	24 VDC
Maximum power consumption	1.3 Amp
Maximum nozzle heater temperature	90° C (194° F)

Nozzle Heater Cable Pin Positions

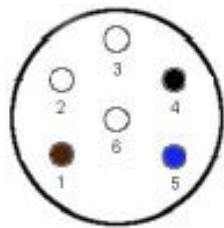

Pin	Color	Function
1	Brown	Heating coil
2	White	Heating coil
3	White	Not assigned
4	Black	PT100 RTD
5	Blue	PT100 RTD
6	White	Not assigned

Appendix B, P-Dot Valve Interface Overview (continued)

Pneumatic Control

To achieve consistent dispensing results, the process parameters must be kept constant. The valve has two air pressure connections (operating pressure and fluid pressure) which must be continuously supplied with air pressure.

The level of pressure depends on the respective process. Each valve must be separately connected to a continuous air supply adjustable through a precision pressure regulator. To keep the operating pressure stable and constant, use a pneumatic accumulator (at least 0.4 liter volume).

Operating Pressure Specification

For the operating pressure, connect 6 mm OD tubing to the plug-in connector on the side of the valve.

Item	Specification
Input air pressure	2–5 bar (29–73 psi)

Fluid Pressure Specifications

For the fluid pressure, connect 4 mm or 6 mm tubing to the syringe barrel adapter (syringe barrel installations only)

Item	Specification
Fluid pressure range	0.1–4.1 bar (1.5–60 psi)
Maximum fluid pressure	100 bar (1450 psi)

CAUTION

Ensure that the pressure limit values for the syringe barrel and air pressure tubing are not exceeded.

NOTE: Nordson EFD recommends installing a precision pressure regulator with a maximum control tolerance of 0.2%.

Valve Configuration Options

- The fluid body can be mounted in other 90-degree positions.
- The operating air pressure connector can be mounted on the opposite side of the valve.
- Standard cartridge centering is 10 cm² (1.6”²); 30 cm² (4.7”²) can be supplied upon request.
- The valve can be supplied without cartridge centering, in which case a tubing connector is mounted on the valve.
- The material to be dispensed can be supplied through tubing instead of through a syringe barrel. This tubing is connected to the valve using an M8 x 1 cap nut.

NORDSON EFD ONE YEAR LIMITED WARRANTY

This Nordson EFD product is warranted for one year from the date of purchase to be free from defects in material and workmanship (but not against damage caused by misuse, abrasion, corrosion, negligence, accident, faulty installation, or by dispensing material incompatible with equipment) when the equipment is installed and operated in accordance with factory recommendations and instructions.

Nordson EFD will repair or replace free of charge any defective part upon authorized return of the part prepaid to our factory during the warranty period. The only exceptions are those parts which normally wear and must be replaced routinely, such as, but not limited to, valve diaphragms, seals, valve heads, needles, and nozzles.

In no event shall any liability or obligation of Nordson EFD arising from this warranty exceed the purchase price of the equipment.

Before operation, the user shall determine the suitability of this product for its intended use, and the user assumes all risk and liability whatsoever in connection therewith. Nordson EFD makes no warranty of merchantability or fitness for a particular purpose. In no event shall Nordson EFD be liable for incidental or consequential damages.

This warranty is valid only when oil-free, clean, dry, filtered air is used, where applicable.



For Nordson EFD sales and service in over 40 countries, contact Nordson EFD or go to www.nordsonefd.com.

Global

800-556-3484; +1-401-431-7000
info@nordsonefd.com

Europe

00800 7001 7001
infoefd.europe@nordsonefd.com

Asia

China: +86 (21) 3866 9006; china@nordsonefd.com
India: +91 80 4021 3600; india@nordsonefd.com
Japan: +81 03 5762 2760; japan@nordsonefd.com
Korea: +82-31-736-8321; korea@nordsonefd.com
SEAsia: +65 6796 9522; sin-mal@nordsonefd.com

Perlast is a registered trademark of Precision Polymer Engineering Limited.
Viton is a registered trademark of E.I. DuPont.
The Wave Design is a trademark of Nordson Corporation.
©2020 Nordson Corporation 7362081 v092421