



You have selected a reliable, high-quality dispensing system from Nordson EFD, the world leader in fluid dispensing. The 797PCP-2K Series progressive cavity pump is designed specifically for industrial dispensing and will provide you with years of trouble-free, productive service.

This manual will help you maximize the usefulness of your 797PCP-2K.

Please spend a few minutes to become familiar with the controls and features. Follow our recommended testing procedures. Review the helpful information we have included, which is based on more than 50 years of industrial dispensing experience.

Most questions you will have are answered in this manual. However, if you need assistance, please do not hesitate to contact EFD or your authorized EFD distributor. Detailed contact information is provided on the last page of this document.

## The Nordson EFD Pledge

Thank You!

You have just purchased the world's finest precision dispensing equipment.

I want you to know that all of us at Nordson EFD value your business and will do everything in our power to make you a satisfied customer.

If at any time you are not fully satisfied with our equipment or the support provided by your Nordson EFD Product Application Specialist, please contact me personally at 800.556.3484 (US), 401.431.7000 (outside US), or [Tara.Tereso@nordsonefd.com](mailto:Tara.Tereso@nordsonefd.com).

I guarantee that we will resolve any problems to your satisfaction.

Thanks again for choosing Nordson EFD.

The image shows a handwritten signature in black ink that reads "Tara".

Tara Tereso, Vice President

# Contents

Contents .....	3
Introduction .....	4
Configuration Options.....	4
How the Pump Operates .....	5
How to Control the Pump.....	5
Specifications.....	6
Operating Features.....	7
Installation .....	8
Unpack the System Components.....	8
Assemble the Pumps.....	9
Mount the Pumps .....	11
Connect the Fluid Supply .....	12
Bleed the Pumps .....	13
Calibrate the Pumps .....	14
Purge Each Pump Through the Manifold (No Mixer) .....	15
Determine Controller Settings, Install the Mixer, and Complete the Installation Process .....	17
Example System Layout: 7197PCP-DIN Controller and 797PCP-2K .....	18
Example System Layout: ValveMate 7197PCP-2K Controller and 797PCP-2K .....	19
Service.....	20
Pump Disassembly .....	20
Pump Assembly.....	23
Pump Storage .....	25
Part Numbers .....	26
797PCP-2Ks .....	26
Pump Motor Cable .....	26
Manifold .....	26
Mixers.....	27
Series 190 Spiral Bayonet Mixers.....	27
Series 295 Square Turbo Bayonet Mixers .....	27
Accessories .....	27
Mounting Brackets .....	27
Fluid Supply.....	28
Fluid Inlet Fittings.....	28
Replacement Parts.....	30
Troubleshooting .....	31

## Introduction

This manual provides specifications, installation, service, part numbers, and troubleshooting information for the 797PCP-2K Series progressive cavity pump for two-component dispensing. 797PCP-2K pumps provide highly accurate meter mix dispensing of two-part assembly fluids for extremely reliable process control. The modular design consists of two 797PCP-2K pumps and a manifold that accommodates a wide range of disposable EFD bayonet static mixers.



Features of the 797PCP-2K:

- Viscosity-independent
- Low pulsing and shearing operation
- High dispensing accuracy
- High repeatability
- Suck-back operation to prevent drooling
- Conditionally appropriate for highly abrasive fluids\*

Typical applications include:

- Coating of printed circuit boards
- Bead dispensing
- Underfilling
- Glue dispensing
- Filling compound dispensing
- Under certain conditions, highly viscous abrasive and corrosive fluid dispensing\*

**NOTE:** Due to the risk of contamination, sealants such as hemp or putty are not recommended.

\*If you will be dispensing highly abrasive or corrosive fluids, refer to “797PCP Selection for Highly Abrasive / Filled Materials” on page 26 for correct pump selection. While 797PCPs are capable of dispensing these fluids, there is a risk of equipment damage if the dispensing process is not properly set up and managed.

## Configuration Options

Pumps come in three sizes that can be configured for multiple mix ratios:

- 0.01 mL/rev per pump
- 0.05 mL/rev per pump
- 0.15 mL/rev per pump

## How the Pump Operates

The core components of the 797PCP-2K are the metal rotor and rubber stator, which form a perfectly sealed metering chamber.

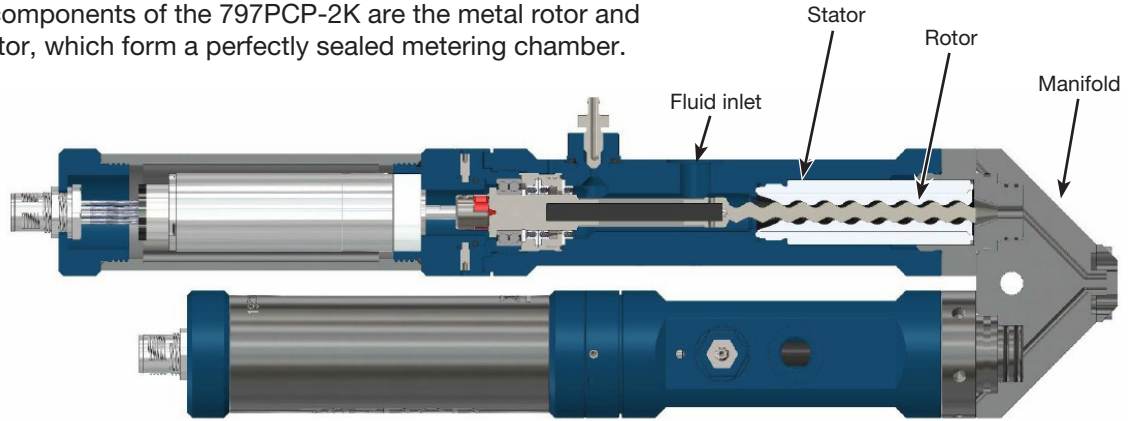

As each chamber rotates, the fluid moves from one sealed cavity to the next, allowing for continuous volumetric dispensing independent of fluid viscosity or changes in viscosity over time. Precisely metering accurate ratios of part A and part B materials through EFD static mixers improve mix quality and bond strength. Output is controlled by a 24 VDC motor.

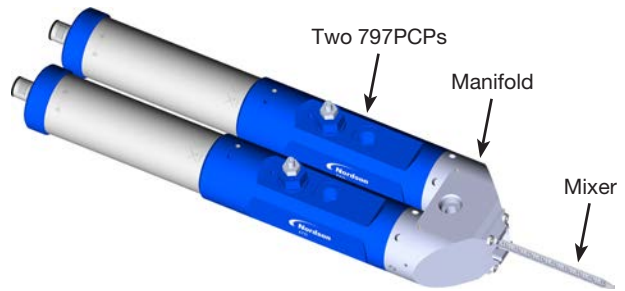

## How to Control the Pump

For best results, use Nordson EFD 797PCP-2Ks with fully integrated 7197PCP controllers, which provide multiple programming modes — Line, Volume, Weight, or Timed — to meet the unique needs of your application. Advanced features, such as the ability to change the rotor speed when dispensing a line around corners, deliver a high level of process control.

For 2K DIN applications, two controllers are required — one for each pump. The controllers are connected for simultaneous control of both pumps.



*The ValveMate™ 7197PCP-2K Controller provides desktop control of the pumps*

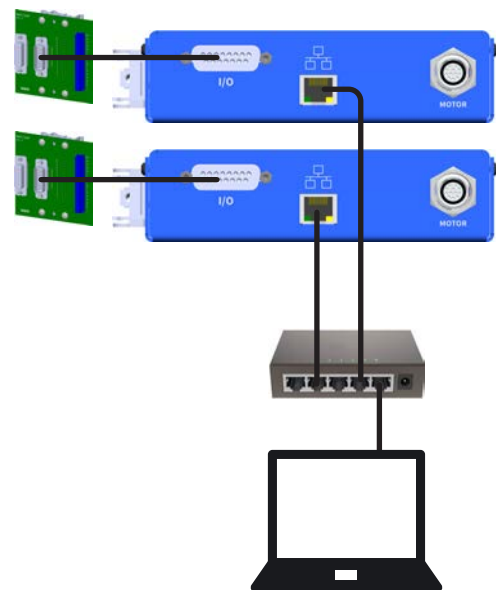

*7197PCP-DIN Controllers allow Internet-based control of the pumps*

## Specifications

**NOTE:** Specifications and technical details are subject to change without prior notification.

Item / Output	797PCP-0.01 mL/rev	797PCP-0.05 mL/rev	797PCP-0.15 mL/rev
Size	261.4L x 36.0DIA mm (10.29L x 1.42DIA")	261.4L x 36.0DIA mm (10.29L x 1.42DIA")	297.9L x 36.0DIA mm (11.73L x 1.42DIA")
Weight	550.0 g (1.2 lb) per pump	550.0 g (1.2 lb) per pump	620.0 g (1.4 lb) per pump
Rotor speed	10–150 RPM (depending on maximum motor speed)		
Motor	24 VDC incremental encoder, planetary gears		
Starting torque	0.22 N•m (1.95 in.-lb)	0.24 N•m (2.12 in.-lb)	0.73 N•m (6.46 in.-lb)
Maximum motor speed (based on fluid viscosity)*	1–800 mPa s: Up to 100% motor speed 800–10,000 mPa s: 90% of maximum motor speed 10,000–25,000 mPa s: 70% of maximum motor speed 25,000–50,000 mPa s: 50% of maximum motor speed 50,000–150,000 mPa s: 25% of maximum motor speed		
Flow rate	0.13–1.95 mL/min per pump	0.59–8.85 mL/min per pump	1.63–24.50 mL/min per pump
Minimum dispensing volume	0.002 mL per pump	0.008 mL per pump	0.01 mL per pump
Dispensing volume per revolution	0.009 mL per pump	0.047 mL per pump	0.139 mL per pump
Repeatability	±1% per pump		
Maximum fluid inlet pressure	0–6 bar (0–87 psi)		
Maximum generated fluid outlet pressure	16–20 bar (232–290 psi)		
Fluid inlet	1/8 NPT		
Fluid outlet	Static mixer adapter		
Mounting	M4		
Fluid chamber	Anodized aluminum		
Rotor	300 stainless steel		
Stator	FFKM (Perfluoroelastomer)		
Operating temperature**	10–40° C (50–104° F)		
Fluid temperature	10–40° C (50–104° F)		
Storage conditions	10–40° C (50–104° F), dry and dust-free; pumps must be stored unassembled		
Enclosure rating (motor)	IP51		
Approvals	CE, WEEE		

All stainless steel parts are passivated.

\*These maximum motor speed values are based on fluids without fillers. The pump is self-priming when certain conditions are met. However, higher viscosity fluids must first be introduced into the pump (pre-pressure). Do not exceed the pre-pressure values stated in the Technical Data Sheet for the fluid. These values can change depending on speed and viscosity. The values provided are guidelines only; maximum speed depends on the application and the environmental conditions. The maximum permitted speed is crucial for the service life or wear of the pump. The inlet pressure must be selected within the stated limits so that continuous filling of the pump is guaranteed.

\*\*Because the viscosity of fluid can change when the temperature changes, the minimum and maximum operating temperature depends on the composition of the O-rings / seals.

### WEEE Directive



This equipment is regulated by the European Union under WEEE Directive (2012/19/EU). Refer to [www.nordsonefd.com/WEEE](http://www.nordsonefd.com/WEEE) for information about how to properly dispose of this equipment.

## Operating Features

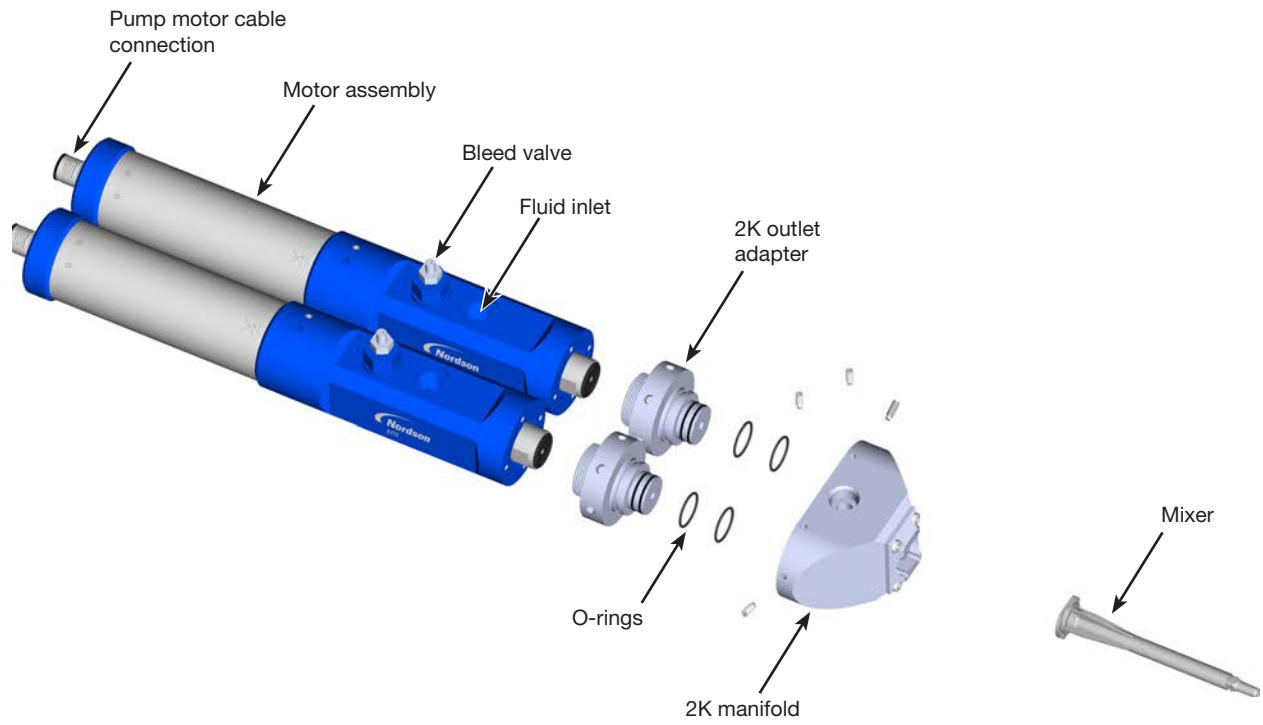

## Installation

Prior to installing the pump, read the associated reservoir and pump controller operating manuals to become familiar with the operation of all components of the dispensing system.

### Unpack the System Components

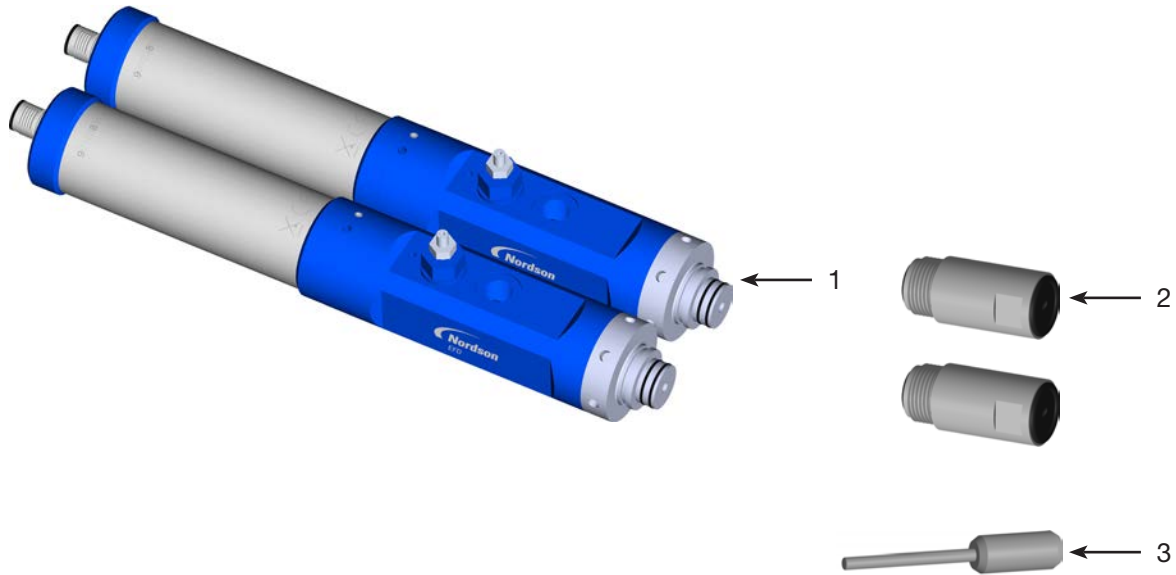

- 1 797PCP-2K
- 2 Stators
- 3 Coupling anti-rotation pin

Ordered separately (not shown)

Pump motor cables

Manifold

Mixer





## Installation (continued)

### Assemble the Pumps

To prevent damage, the stator is shipped separately. Follow this procedure to install the stator on both pumps.

You will need the following items:

- M3 hex wrench 
- Spanner wrench 
- Coupling anti-rotation pin (shipped with the pump) 
- 14 mm low-profile open-end wrench (for stator installation or removal)
- Process fluid (or compatible cleaning fluid)

#### CAUTION

Risk of equipment damage. Do not dry-assemble the rotor and stator. Excessive friction of dry components can damage the pump.

#### CAUTION

Do not use water with a 797PCP. Doing so can damage the lubricated shaft and bearings.

1. Use an M3 hex wrench to loosen the dog head set screws that secure the manifold, then remove the manifold.

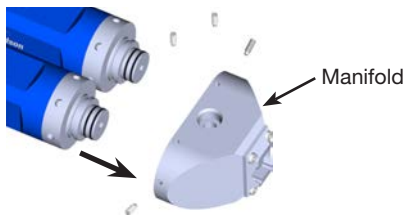

2. Use a spanner wrench to remove the 2K outlet adapters. 

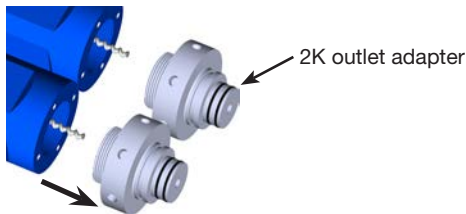

3. Wet the rotors and stators with the process fluid (or any appropriate lubricant that is compatible with the process fluid).

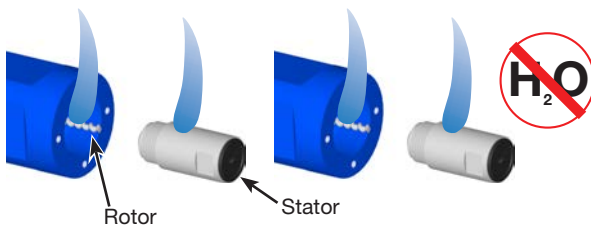

## Installation (continued)

4. Insert the coupling anti-rotation pin into the housing to secure the coupling. If needed, carefully turn the stator / rotor assembly until you feel the pin drop in between the tabs of the gear ring.

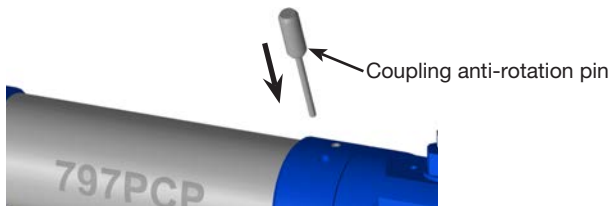

5. Use a 14 mm low profile wrench to carefully screw the stators clockwise first onto the rotor, and then into the threads inside the pump housing.



6. Thread the outlet adapters onto the pump bodies and hand tighten. Use the spanner wrench for final tightening.

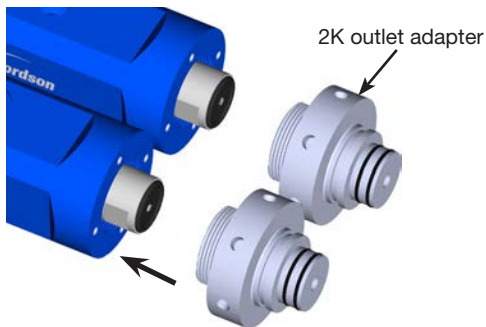

## Installation (continued)

- Ensuring that the O-rings are in place on the 2K outlet adapters, position the manifold on the pumps and use an M3 hex wrench to secure it with the set screws removed previously.

**NOTE:** Do not install the mixer at this time.

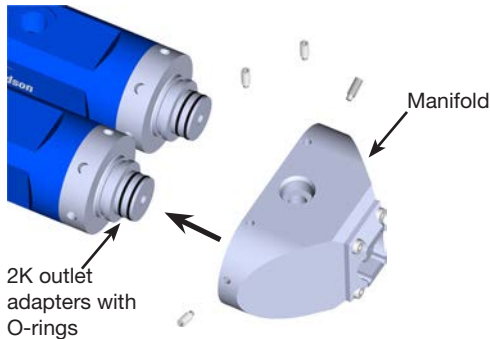

Pump assembly is now complete. Continue to “Mount the Pumps” below.

## Mount the Pumps

You will need the following items:

- M3 hex wrench 
- Pump mounting bracket (refer to “Accessories” on page 27)

Determine the pump orientation and rotation that will be suitable for your application and then mount the pumps on the production line. 797PCP-2Ks can be mounted in any orientation (vertical, diagonal, horizontal, etc.).

**NOTE:** If the pump is being incorporated into an automated dispensing system, ensure that the pump is mounted securely on the Z axis such that it cannot loosen during dispensing. The mounting method should also allow accurate adjustment of the distance between the mixer and the workpiece using a device such as a laser or touch-type height sensor.

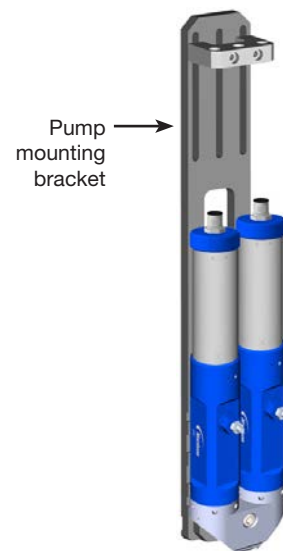

## Installation (continued)

### Connect the Fluid Supply

You will need the following items:

- 8 mm low-profile open-end wrench (for the bleed valve hex nut)
- Fluid supply components and fluid inlet fittings (refer to “Accessories” on page 27)
- Process fluid (or compatible cleaning fluid)

#### CAUTION

Risk of equipment damage. Do not over-tighten fittings. Doing so can damage the anodized aluminum pump housing.

#### CAUTION

Do not use water with a 797PCP. Doing so can damage the lubricated shaft and bearings.

1. Connect the process fluid supplies to the fluid inlets.  
**Do not pressurize the fluid supplies at this time.**

#### NOTES:

- Nordson EFD recommends using a compatible cleaning fluid for initial startup.
- Several fluid fitting options are available. Refer to “Accessories” on page 27.

2. Install any system components other than the 797PCP-2Ks that will comprise the complete dispensing system, including the pump controller. Refer to the following examples:

- “Example System Layout: 7197PCP-DIN Controller and 797PCP-2K” on page 18
- “Example System Layout: ValveMate 7197PCP-2K Controller and 797PCP-2K” on page 19

**NOTE:** For example, if you are using a fluid reservoir, position and install all the fluid reservoir components. For all ancillary components, such as the pump controller, refer to the quick start guide and / or operating manual provided with those components for installation and setup instructions.

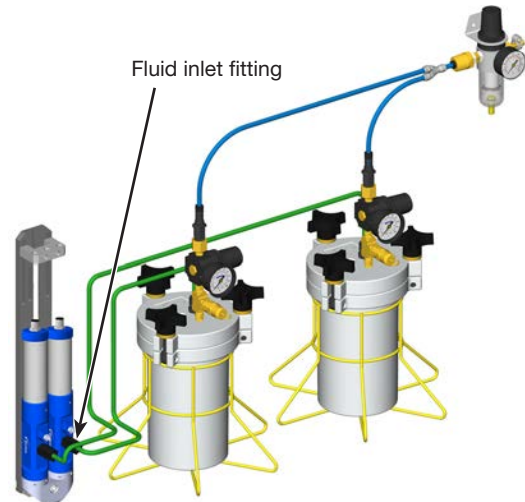

#### CAUTION

Risk of equipment damage. Bleed the 797PCP-2Ks and then purge with the dispensing material before placing them into operation. Failure to bleed and purge before initial startup will damage the pumps.

3. Continue to “Bleed the Pumps” on page 13.

# Installation (continued)

## Bleed the Pumps

To bleed Pump 1:

### WARNING

Risk of personal injury. Ensure that the fluid supply pressure is set very low. Higher pressures can cause low viscosity fluids to spray from the pump.

1. Set the fluid pressure to approx 0.3 bar (5 psi), depending on the viscosity of the fluid.
2. Place a towel or container under the pump bleed valve and then use an 8 mm low-profile open-end wrench to turn the bleed valve hex screws counterclockwise (about 1/2 turn or less).
3. Allow fluid to seep from the bleed valve until it is free of trapped air (no air bubbles).
4. Close the bleed valve.
5. Continue to the next procedure to bleed Pump 2.

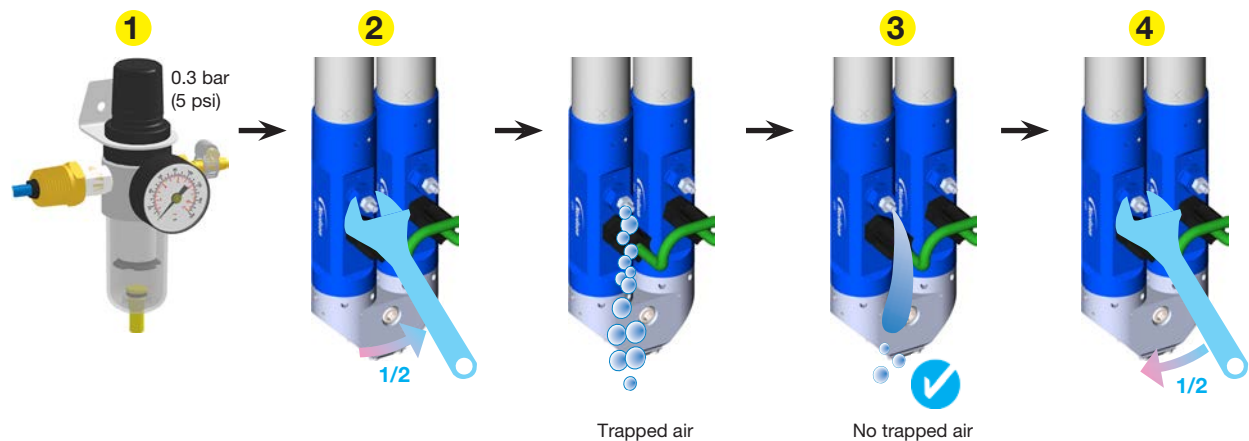

## Installation (continued)

### Bleed the Pumps (continued)

To bleed Pump 2:

#### WARNING

Risk of personal injury. Ensure that the fluid supply pressure is set very low. Higher pressures can cause low viscosity fluids to spray from the pump.

1. Set the fluid pressure to approx 0.3 bar (5 psi), depending on the viscosity of the fluid.
2. Place a towel or container under the pump bleed valve and then use an 8 mm low-profile open-end wrench to turn the bleed valve hex screws counterclockwise (about 1/2 turn or less).
3. Allow fluid to seep from the bleed valve until it is free of trapped air (no air bubbles).
4. Close the bleed valve.
5. Continue to the next procedure to calibrate the pumps.

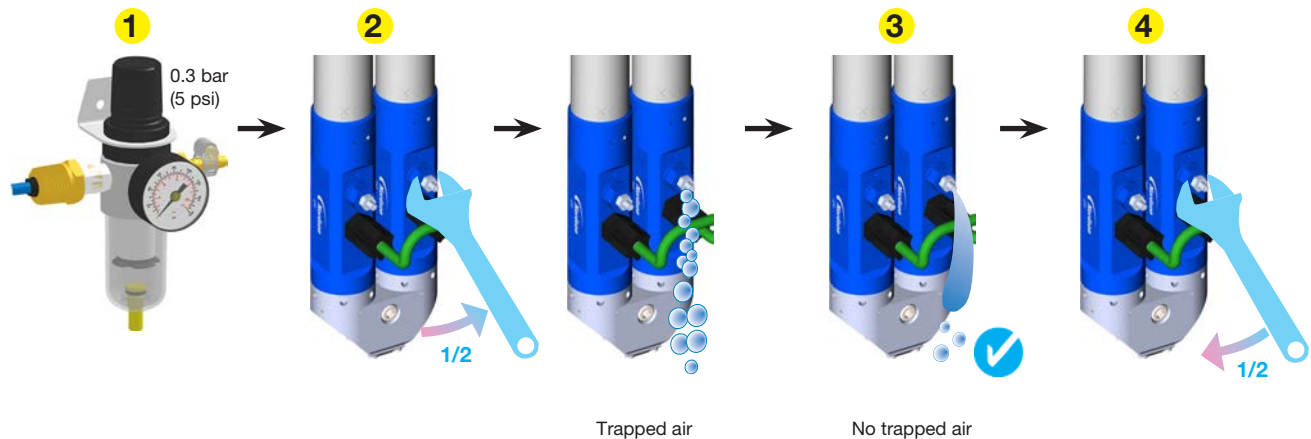

### Calibrate the Pumps

Before a pump is purged for the first time, it must be calibrated to the controller.

**Go to the controller manual and follow the procedure for initial startup and calibration. Return here and then continue to “Purge Each Pump Through the Manifold (No Mixer)” on page 15.**

## Installation (continued)

### Purge Each Pump Through the Manifold (No Mixer)

Before creating any programs or placing the system into operation for the first time, purge each pump without a mixer installed.

#### CAUTION

Risk of equipment damage. **Do not operate a 797PCP-2K without material.** Excessive friction of dry components can damage the pump.

- Ensure that:
  - The pumps have been calibrated. Initial purging will work only after a calibration has been performed.
  - Both bleed valves are closed (turned fully clockwise).
  - The fluid supply pressure is set to 0.3 bar (5 psi).
  - The mixer is not installed.

**NOTE:** Each pump must be purged separately.

- Place a paper towel or container under the manifold.

#### To purge Pump 1 through the manifold:

- Refer to the table below to purge Pump 1 through the manifold based on the type of controller in your system:

**NOTE:** For programming instructions specific to your controller, refer to the controller manual.

Purging Pump 1 through the manifold

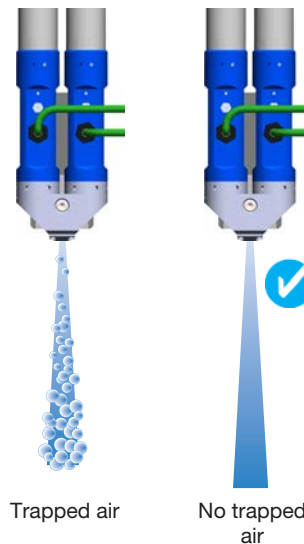

Your Controller	Purge Procedure
 <p>7197PCP-DIN</p>	<ol style="list-style-type: none"> <li>Trigger the purge initiate circuit.               <p><b>NOTE:</b> The default purge RPM is 10. To change the RPM, refer to the procedure for adjusting the purge RPM in the controller manual.</p> </li> <li>Allow fluid to flow from the manifold until it is completely free of trapped air.</li> <li>Stop the purge by removing the purge initiate signal.</li> <li>Continue to “To purge Pump 2 through the manifold:” on page 16.</li> </ol>

## Installation (continued)

### Purge Each Pump Through the Manifold (No Mixer) (continued)

#### To purge Pump 1 through the manifold (continued):

Your Controller	Purge Procedure
 <p>ValveMate 7197PCP-2K</p>	<ol style="list-style-type: none"> <li>Navigate to the LINE program screen. <b>NOTE:</b> The Line program will be used to purge the pump.</li> <li>Ensure that the pump button is set to PUMP1.</li> <li>Select the ENABLE LINE PROGRAM radio button.</li> <li>Enter the following settings: <ul style="list-style-type: none"> <li>RPM = 10</li> <li>Reverse % = 1</li> <li>Correction Factor = 1</li> <li>Analog Off</li> </ul> <b>NOTE:</b> The default purge RPM is 10. To change the purge RPM, refer to the procedure for adjusting the purge RPM in the controller manual. </li> <li>Select SUBMIT.</li> <li>From the Main screen, select LOAD, toggle the pump button to PUMP2, then select the DISABLE PUMP radio button. <b>NOTE:</b> Do not make any more selections; if you do, the pump will be re-enabled.</li> <li>Press the foot pedal.</li> <li>Allow fluid to flow from the manifold until it is completely free of trapped air.</li> <li>Release the foot pedal.</li> <li>Continue to the next procedure to purge Pump 2 through the manifold.</li> </ol>

#### To purge Pump 2 through the manifold:

- Refer to the table below to purge Pump 2 through the manifold based on the type of controller in your system:

Your Controller	Purge Procedure
 <p>7197PCP-DIN</p>	<ol style="list-style-type: none"> <li>Trigger the purge initiate circuit.</li> <li>Allow fluid to flow from the manifold until it is completely free of trapped air.</li> <li>Stop the purge by removing the purge initiate signal.</li> <li>Continue to “Determine Controller Settings, Install the Mixer, and Complete the Installation Process” on page 17.</li> </ol>



## Installation (continued)

### Purge Each Pump Through the Manifold (No Mixer) (continued)

To purge Pump 2 through the manifold (continued):

Your Controller	Purge Procedure
 <p>ValveMate 7197PCP-2K</p>	<ol style="list-style-type: none"> <li>a. Navigate to the LINE program screen.           <p><b>NOTE:</b> The Line program will be used to purge the pump.</p> </li> <li>b. Select the pump button to toggle to the PUMP2 screen.</li> <li>c. Select the ENABLE LINE PROGRAM radio button.</li> <li>d. Enter the following settings:           <ul style="list-style-type: none"> <li>• RPM = 10</li> <li>• Reverse % = 1</li> <li>• Correction Factor = 1</li> <li>• Analog Off</li> </ul> </li> <li>e. Select SUBMIT.</li> <li>f. From the Main screen, select LOAD, toggle the pump button to PUMP1, then select the DISABLE PUMP radio button.           <p><b>NOTE:</b> Do not make any more selections; if you do, the pump will be re-enabled.</p> </li> <li>g. Press the foot pedal.</li> <li>h. Allow fluid to flow from the manifold until it is completely free of trapped air.</li> <li>i. Release the foot pedal.</li> <li>j. Continue to “Determine Controller Settings, Install the Mixer, and Complete the Installation Process” below.</li> </ol>

### Determine Controller Settings, Install the Mixer, and Complete the Installation Process

Before installing the mixer, you must determine and enter the correct settings for your Part A (Pump 1) and Part B (Pump 2) process fluids (referred to as components). Nordson EFD recommends using the Volume program for this part of the installation process. After you have set up the Volume program, you can install the mixer, purge air from the mixer, and test the process.

**Go to the “Volume Example Program” in the controller manual to enter the best settings for your process.**

**Refer to the controller manual for all programming and operating instructions specific to your controller.**

# Installation (continued)

## Example System Layout: 7197PCP-DIN Controller and 797PCP-2K

For controller setup and system startup and testing, refer to the controller operating manual.

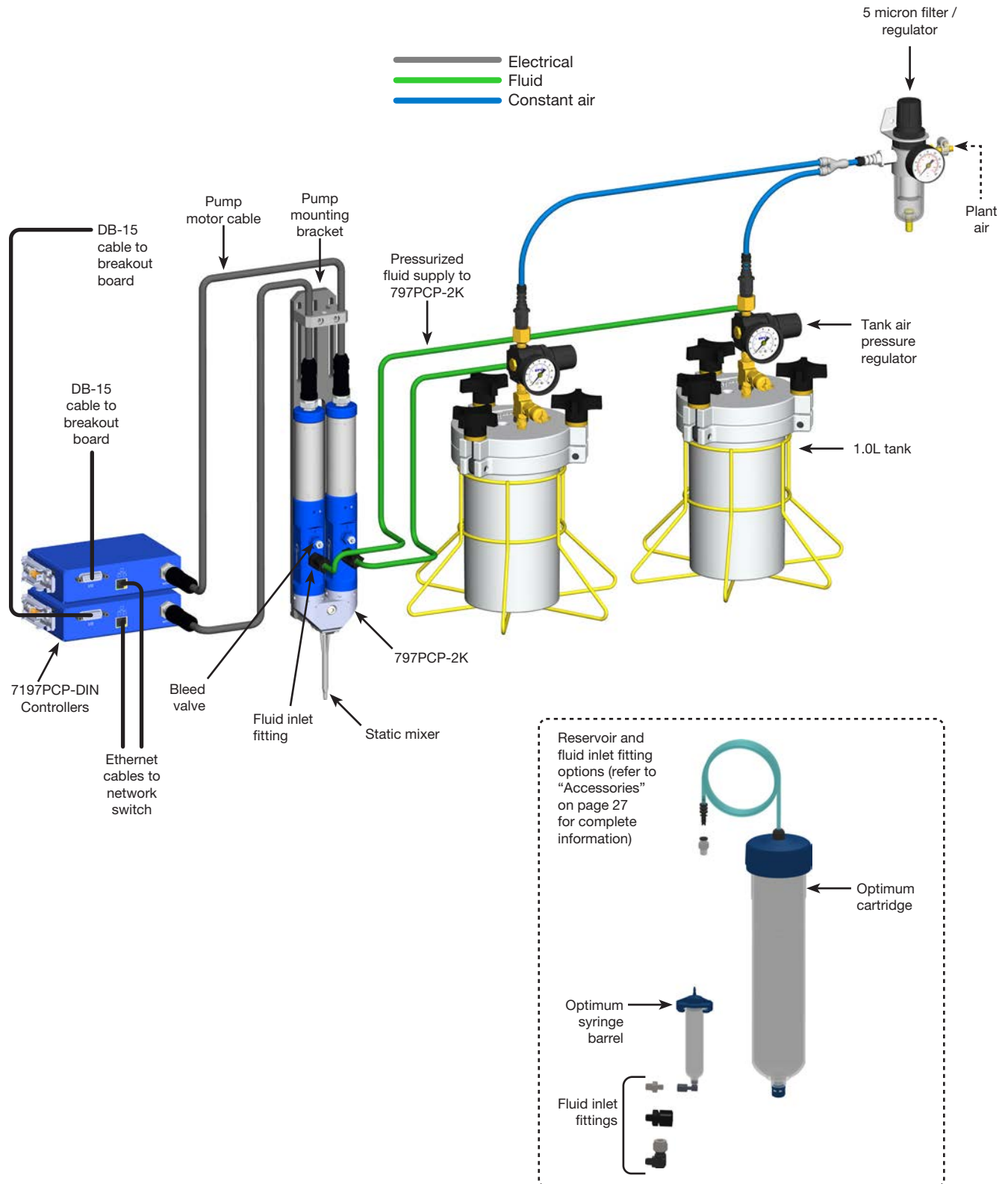

## Installation (continued)

### Example System Layout: ValveMate 7197PCP-2K Controller and 797PCP-2K

For controller setup and system startup and testing, refer to the controller operating manual.

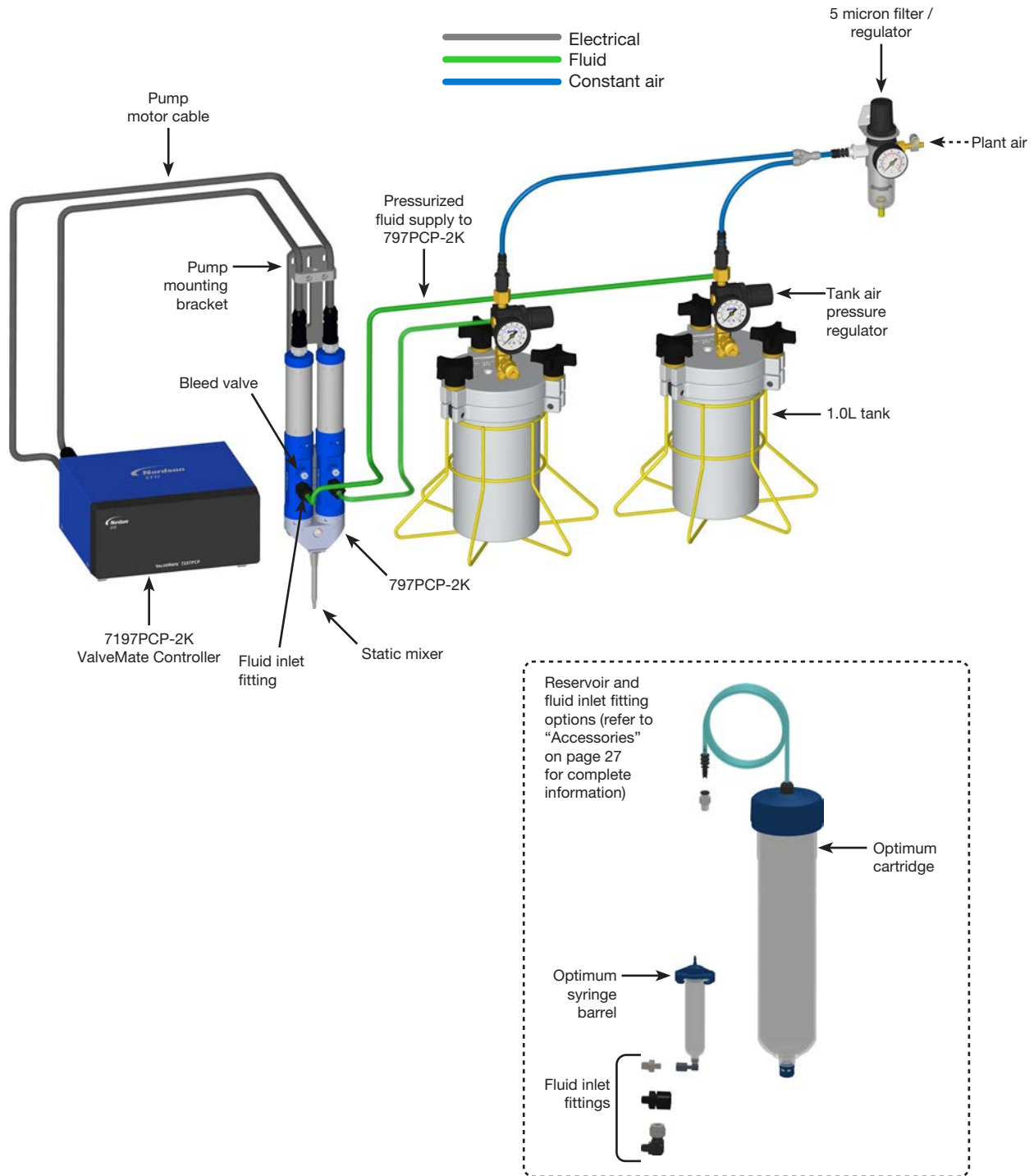

## Service



797PCP-2Ks are largely maintenance-free. However, some operating conditions may subject the gaskets, bearings, stator, and rotor to wear, requiring them to be replaced at regular intervals. Regularly review your performance data to determine appropriate service intervals. Any time the pump is serviced, also perform the following actions:

- Check all fastening screws and connections to ensure they are securely tightened; re-tighten as needed.
- Check the coupling (elastomer) for wear.
- Check the leak resistance of the pump, especially the shaft seals.

## Pump Disassembly

**NOTE:** During disassembly, observe the position of the pump components in relation to each other. Nordson EFD recommends marking the position of the components and numbering them consecutively.

### Required Tools

- M3 hex wrench 
- Spanner wrench 
- Coupling anti-rotation pin (shipped with the pump) 
- 14 mm low-profile open-end wrench (for stator removal or installation)

### Preparation for Service

1. Shut off the air supply to the system.
2. Stop the fluid supplies to the pumps and disconnect fluid supply tubing.
3. Disconnect the pump motor cables from the controllers.
4. Remove the pumps from the pump bracket.
5. Remove the mixer.

### Remove the 2K Outlet Adapters and Manifold

1. Use an M3 hex wrench to loosen the dog head set screws that secure the manifold, then remove the manifold.
2. Use a spanner wrench to remove the 2K outlet adapters. 

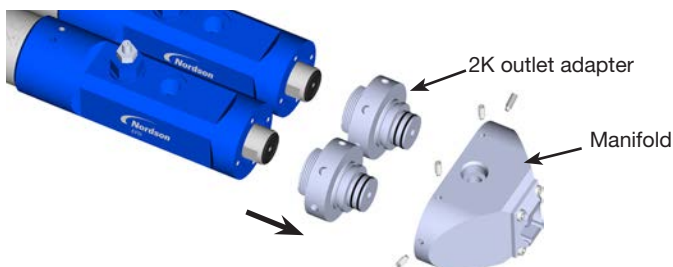

## Pump Disassembly (continued)

### Remove the Stators

**NOTE:** Perform this procedure for each pump.

1. Insert the coupling anti-rotation pin into the housing to secure the coupling. If needed, carefully turn the stator / robot assembly until you feel the pin drop in between the tabs of the gear ring.

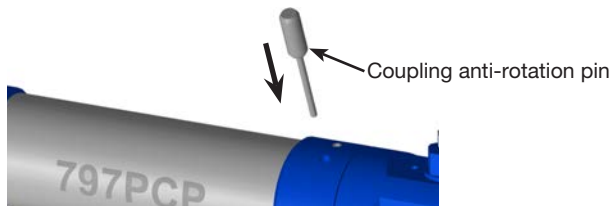

2. After the coupling is secured, use a 14 mm low-profile open-end wrench to carefully turn the stator counterclockwise to remove it.



3. If the pumps will be returned to normal operation directly after service, continue to “Remove the Fluid Bodies” on page 22 to complete the pump disassembly.

If the pumps will be stored, then disassembly is complete. Refer to “Pump Storage” on page 25 for details.

## Pump Disassembly (continued)

### Remove the Fluid Bodies

**NOTE:** Perform this procedure for each pump.

1. Use an M3 hex wrench to loosen the dog head set screws located in the mounting flange, then remove the motor assembly.



2. Unscrew and remove the mounting flange.

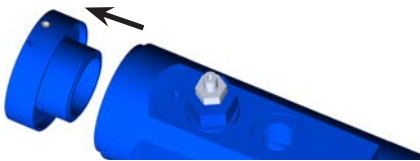

3. Remove the seal bearing and rotor assembly.

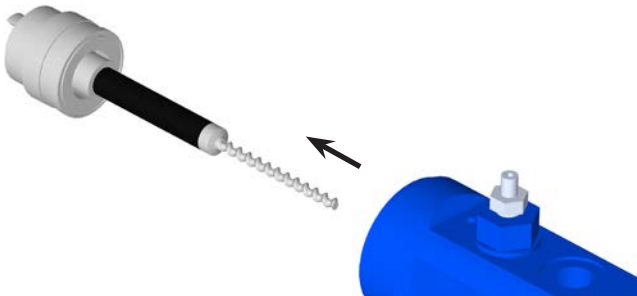

4. Carefully isolate the seal bearing assembly from the rotor.
5. Disassemble the seal bearing assembly and inspect the components. Obtain replacements for any damaged components.

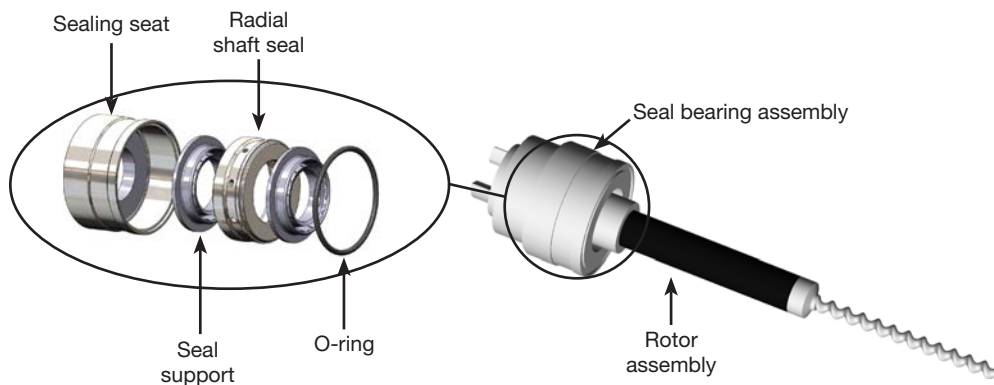

## Pump Assembly

During assembly:

- Inspect O-rings and seals for damage and replace with new ones as needed.
- Always replace PTFE gaskets.
- Completely remove any sealant residue.

### Reassemble the Fluid Bodies

**NOTE:** Perform this procedure for each pump.

1. Assemble the seal bearing assembly and install it on the rotor assembly.

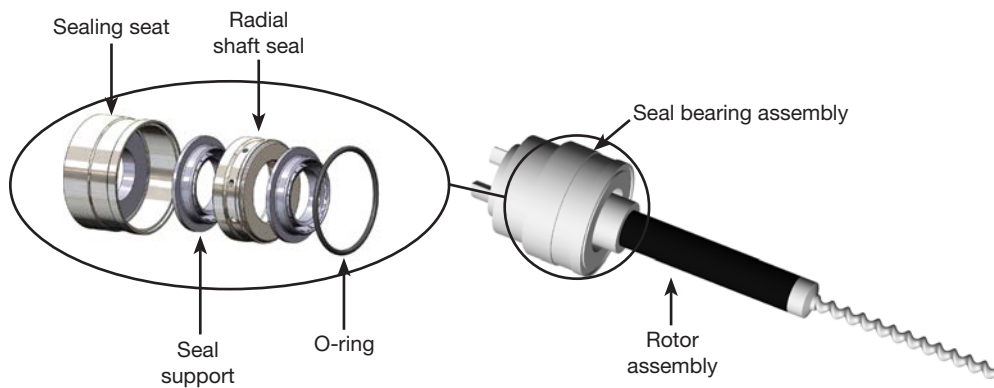

2. Insert the seal bearing and rotor assembly in the pump housing.

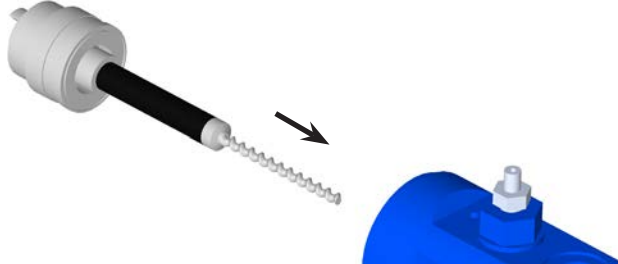

3. Reinstall the mounting flange.

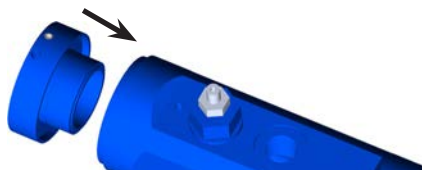

4. Use an M3 hex wrench to install the motor assembly using the two dog head set screws removed previously.

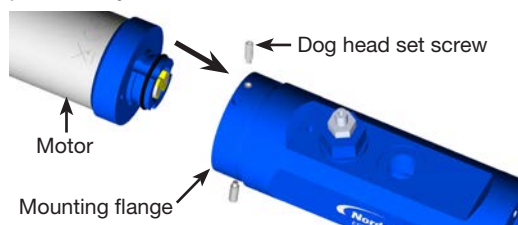

## Pump Assembly (continued)

### Install the Stators

**NOTE:** Perform this procedure for each pump.

1. Insert the coupling anti-rotation pin into the housing to secure the coupling. If needed, carefully turn the stator / robot assembly until you feel the pin drop in between the tabs of the gear ring.

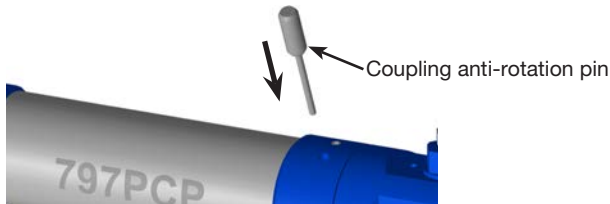

2. Carefully screw the stator clockwise first onto the rotor, and then into the threads inside the pump housing, until it is fully tightened in the fluid body housing. Avoid over-torquing.



3. Thread the 2K outlet adapters onto the pump bodies and use the spanner wrench to tighten.
4. Ensuring that the O-rings are in place, position the 2K manifold onto the pumps and secure it with the set screws removed previously.

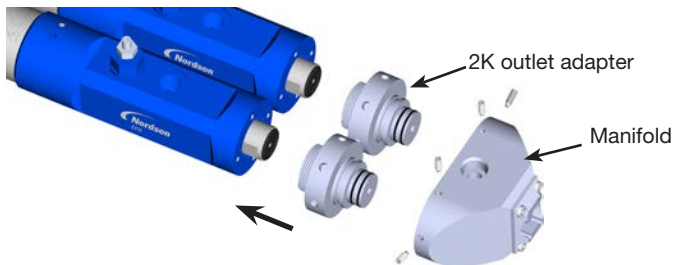

5. Install the mixer.
  6. After every rotor or stator change, calibrate the system. Refer to the controller manual for the calibration procedure.
- Pump assembly is now complete. Reinstall the pumps on the production line and restore the system to normal operation.



## Pump Storage

For long periods of downtime or for storage, remove the stator from the rotor to prevent rotor deformation. Refer to the following procedures to remove the stator:

- “Remove the 2K Outlet Adapters and Manifold” on page 20
- “Remove the Stators” on page 21

To restore the pumps to normal operation, refer to “Assemble the Pumps” on page 9.

Ensure that the following conditions are met for pump storage:

- The stator is removed from the rotor.
- The maximum ambient storage temperature is 25° C (77° F); the relative humidity maximum is 80%.
- Pump and motor assemblies are stored in enclosed rooms.
- Pumps are protected against sunlight and UV light.
- No aggressive or corrosive materials or agents are stored nearby.

## Part Numbers

797PCP-2Ks, pump motor cables, and manifolds are ordered separately.

### 797PCP-2Ks

All 797PCPs include the coupling anti-rotation tool.

Item	Part #	Description
	7364203	797PCP-2K-0.01 pump, 0.01 mL per revolution, 0.13–1.95 mL per minute flow rate
	7364204	797PCP-2K-0.05 pump, 0.05 mL per revolution, 0.59–8.85 mL per minute flow rate
	7364205	797PCP-2K-0.15 pump, 0.15 mL per revolution, 1.63–24.50 mL per minute flow rate

### 797PCP Selection for Highly Abrasive / Filled Materials

Although 797PCPs can be used to dispense particle-filled materials, doing so will cause premature wear to the rotor and stator, requiring rotor / stator replacement. When using a 797PCP to dispense particle-filled materials, first consult with your Nordson EFD representative. Proper pump selection will be based on the percentage of particles in the fluid, the type and size of the particles, and the shape (sharp, soft and round, or hard and abrasive).

#### CAUTION

Risk of equipment damage. The dispensing of highly abrasive / filled materials or pastes causes premature rotor / stator damage.

### Pump Motor Cable

Item	Part #	Description
	7364280	Pump motor cable, 5 m (16.4 ft)

### Manifold

Item	Part #	Description
	7364206	797PCP-2K manifold, required for configuring the system, accommodates two pumps and a mixer (includes set screws)

## Mixers

### Series 190 Spiral Bayonet Mixers

These disposable spiral mixers deliver complete and thorough mixing in a wide range of sizes. Five diameters are available with four outlet styles. The H-Tapered outlet is compatible with a luer lock adapter for attaching dispense tips for more precise fluid deposits.



### Series 295 Square Turbo Bayonet Mixers

These disposable square static mixers are shorter than comparable spiral mixers. The patented design ensures superior mixing performance while reducing material waste.



## Accessories

### Mounting Brackets

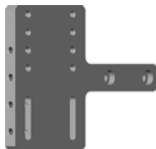





Item	Part #	Description
	7364529	797PCP-2K pump mounting bracket, PROPlus / PRO Series, E / EV Series and GV Series robots <b>NOTE:</b> To use this bracket on any PROPlus / PRO robot or a G8V robot, also order P/N 7364856.
	7364856	Camera mounting bracket, 797PCP <b>NOTE:</b> To mount a 797PCP-2K on any PRO / PROPlus robot or on a G8V robot, use this bracket in tandem with the 797PCP-2K pump mounting bracket. This bracket is attached to the robot camera.

## Accessories (continued)

### Fluid Supply

Many fluid supply options are available. Contact your Nordson EFD application specialist for assistance. For a complete list of Optimum™ components, see [www.nordsonefd.com/Optimum](http://www.nordsonefd.com/Optimum).





### Fluid Inlet Fittings

Item	Part #	Description	Material	Color
	7364741	Fitting: 1/8 NPT x M8 reducer <b>NOTE:</b> Use with syringe barrel adapter P/Ns 7825120 and 7825121.	Stainless steel	Silver
	7825120	Steel luer lock adapter for syringe barrels <b>NOTE:</b> Use with fitting P/N 7364741.	Stainless steel	Silver
	7825121	Plastic luer lock adapter for syringe barrels <b>NOTE:</b> Use with fitting P/N 7364741.	Plastic (PEEK)	Natural
	7014732	Fitting: 1/8 NPT x 3/8 compression elbow, stainless steel	Stainless steel	Silver
	7021462	Fitting: 1/8 NPT x 1/8 barb	Nylon	Black
	7021532	Fitting: 1/8 NPT x 1/4 compression	Polypropylene	Black
	7007038	Fitting: 1/8 NPT x 3/8 compression	Polypropylene	Black

*Continued on next page*

## Accessories (continued)

### Fluid Inlet Fittings (continued)

Item	Part #	Description	Material	Color
	7021499	Fitting: 1/8 NPT x 1/4 compression elbow	Polypropylene	Black
	7020903	Fitting: Barrel to 1/8 NPT elbow	Polypropylene	Black
	7021464	Elbow fitting: 1/8 NPT x 1/8 barb	Polypropylene	Clear
	7020136	Fitting: 1/8 NPT x 3/8 compression elbow	Nylon	Black

# Replacement Parts

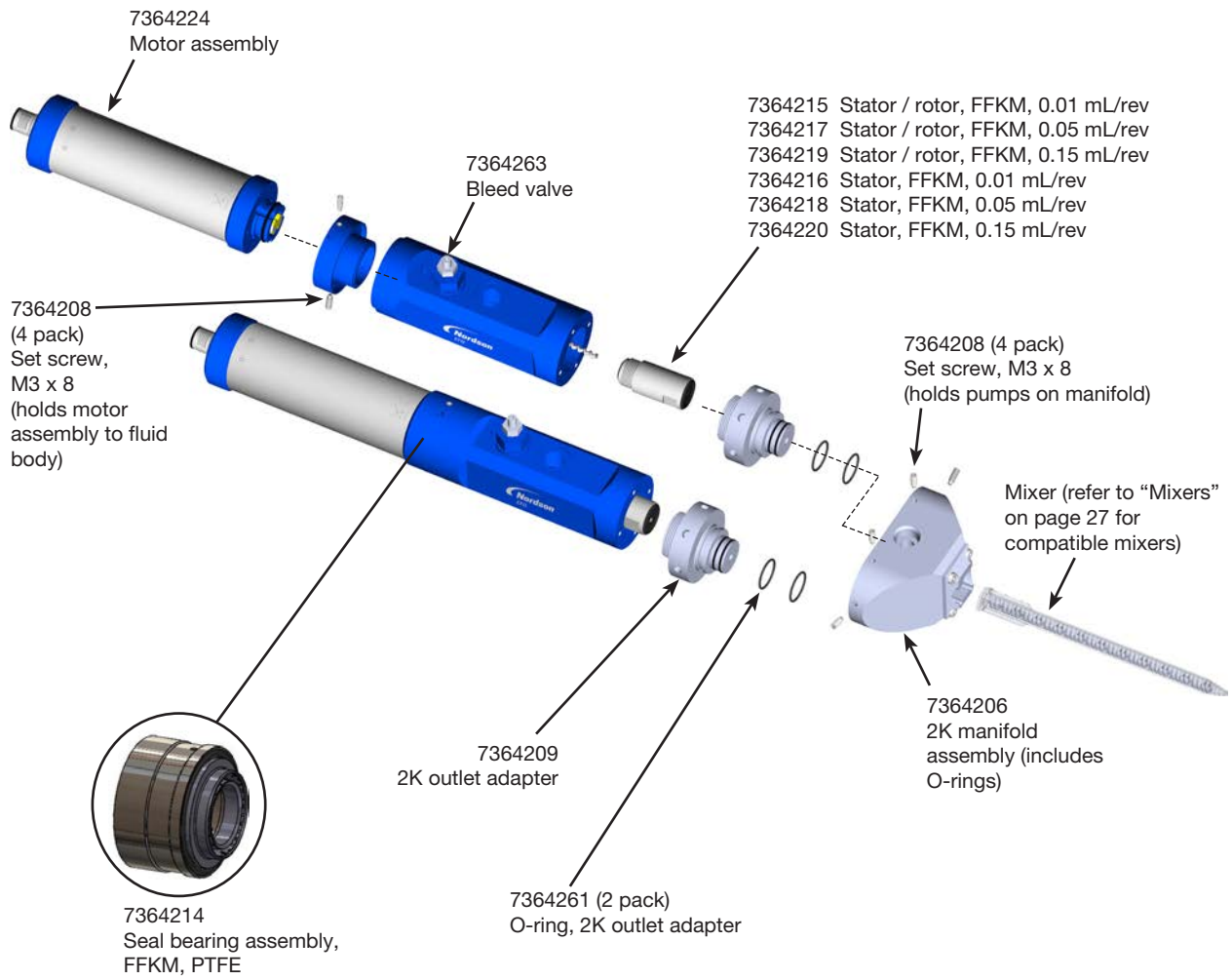

## Troubleshooting

Problem	Possible Cause	Corrective Action
No fluid flow	Mixer clogged	Replace the mixer.
	Loose or disconnected pump motor cable	Check the motor cable connection. Tighten if needed.
	Fluid supply low or empty	 <b>CAUTION</b> Risk of equipment damage. <b>Do not operate a 797PCP-2K without material.</b> Excessive friction of dry components can damage the pump. Check the fluid supply.
	Fluid pressure too low	Increase the fluid pressure.
Inconsistent deposit size	Fluid dried or cured	Replace the fluid supply with fresh fluid.
	Fluid pressure fluctuating	Ensure that the fluid pressure remains constant.
	Dispense time too short	Increase the dispense time. Refer to the controller manual for information on controlling the pump.
	Trapped air in the fluid supply	Purge the system.
Skipped deposits	Intermittent pump motor signal	Check the pump motor cable and motor assembly; tighten connections or replace components as needed.
	Trapped air in the fluid supply	Purge the system.
Fluid drools after pump is turned off	Trapped air in the fluid supply	Purge the system.
	Suck-back setting too low	Adjust the suck-back setting (Reverse %). Refer to the controller manual.

## NORDSON EFD ONE YEAR LIMITED WARRANTY

This Nordson EFD product is warranted for one year from the date of purchase to be free from defects in material and workmanship (but not against damage caused by misuse, abrasion, corrosion, negligence, accident, faulty installation, or by dispensing material incompatible with equipment) when the equipment is installed and operated in accordance with factory recommendations and instructions.

Nordson EFD will repair or replace free of charge any defective part upon authorized return of the part prepaid to our factory during the warranty period. The only exceptions are those parts which normally wear and must be replaced routinely, such as, but not limited to, valve diaphragms, seals, valve heads, needles, and nozzles.

In no event shall any liability or obligation of Nordson EFD arising from this warranty exceed the purchase price of the equipment.

Before operation, the user shall determine the suitability of this product for its intended use, and the user assumes all risk and liability whatsoever in connection therewith. Nordson EFD makes no warranty of merchantability or fitness for a particular purpose. In no event shall Nordson EFD be liable for incidental or consequential damages.

This warranty is valid only when oil-free, clean, dry, filtered air is used, where applicable.



For Nordson EFD sales and service in over 40 countries, contact Nordson EFD or go to [www.nordsonefd.com](http://www.nordsonefd.com).

**Global**

800-556-3484; +1-401-431-7000  
[info@nordsonefd.com](mailto:info@nordsonefd.com)

**Europe**

00800 7001 7001  
[infoefd.europe@nordsonefd.com](mailto:infoefd.europe@nordsonefd.com)

**Asia**

China: +86 (21) 3866 9006; [china@nordsonefd.com](mailto:china@nordsonefd.com)  
India: +91 80 4021 3600; [india@nordsonefd.com](mailto:india@nordsonefd.com)  
Japan: +81 03 5762 2760; [japan@nordsonefd.com](mailto:japan@nordsonefd.com)  
Korea: +82-31-736-8321; [korea@nordsonefd.com](mailto:korea@nordsonefd.com)  
SEAsia: +65 6796 9522; [sin-mal@nordsonefd.com](mailto:sin-mal@nordsonefd.com)

The Wave Design is a trademark of Nordson Corporation.  
©2021 Nordson Corporation 7364340 v012821