

MicroCoat MC800 Lubrication Systems

Operating Manual



Original Instructions

Electronic pdf files of Nordson EFD manuals are also available at www.nordsonefd.com



You have selected a reliable, high-quality dispensing system from Nordson EFD, the world leader in fluid dispensing. MicroCoat® MC800 lubrication systems are designed specifically for industrial dispensing and will provide you with years of trouble-free, productive service.

This manual will help you maximize the usefulness of your MicroCoat MC800 lubrication system.

Please spend a few minutes to become familiar with the controls and features. Follow our recommended testing procedures. Review the helpful information we have included, which is based on more than 50 years of industrial dispensing experience.

Most questions you will have are answered in this manual. However, if you need assistance, please do not hesitate to contact EFD or your authorized EFD distributor. Detailed contact information is provided on the last page of this document.

The Nordson EFD Pledge

Thank You!

You have just purchased the world's finest precision dispensing equipment.

I want you to know that all of us at Nordson EFD value your business and will do everything in our power to make you a satisfied customer.

If at any time you are not fully satisfied with our equipment or the support provided by your Nordson EFD Product Application Specialist, please contact me personally at 800.556.3484 (US), 401.431.7000 (outside US), or Ferran.Ayala@nordsonefd.com.

I guarantee that we will resolve any problems to your satisfaction.

Thanks again for choosing Nordson EFD.

Ferran

Ferran Ayala, Vice President

Contents

Contents	3
Introduction	4
Nordson EFD Product Safety Statement	5
Halogenated Hydrocarbon Solvent Hazards	6
High Pressure Fluids	6
Qualified Personnel	6
Intended Use	7
Regulations and Approvals	7
Personal Safety	7
Fire Safety	8
Preventive Maintenance	8
Important Disposable Component Safety Information	9
Action in the Event of a Malfunction	9
Disposal	9
Specifications	10
MC800 Controller	10
MC785M & MC785M-WF Valves	10
MicroCoat Tank Reservoirs	11
4000FLT MC Filter Elements	11
Declaration of Conformity	12
How the System Operates	13
Controller Features	14
Tank Reservoir Features	16
System Assembly	17
Mount the Spray Valves	17
Spray Area Coverage	17
Installation / Removal of Flow Control / Block-off Plug from Manifold	18
Set Up the Controller	18
Connect the Press Air Solenoid	18
Press Air Solenoid Diagram	19
Connect the Valve Hoses	20
Connect the Tank Reservoir and Lubricant Filter	20
System Assembly Diagram	21
Connect the Emergency Stop Circuit	22
System Setup	23
Check All Connections	23
Fill the Tank Reservoir	23
Prime the System	23
Adjust the Spray	24
Preventive Maintenance	24
Spray Valve Maintenance	25
Part Numbers	26
Accessories	26
Replacement Parts	27
MC785M Series Spray Valves	27
Air and Fluid Flow	28
MC685M and MC686M Tanks	29
Troubleshooting	30
Technical Data	31
Air Flow Schematic	31
Fluid Flow Schematic	31

Introduction

The MicroCoat System provides precise lubrication control for metal stamping operations.

The MC800 controller, MC785M Series spray valves and the MicroCoat tank reservoirs are all produced to exacting specifications and thoroughly tested prior to shipment.

The MC785M Series valves are designed for long life without maintenance when clean lubricant is used.

To obtain the maximum performance from your MicroCoat System, please read through these instructions carefully.

Our goal is to build not only the finest equipment but also to build long-term customer relationships founded on superb quality, service, value and trust.

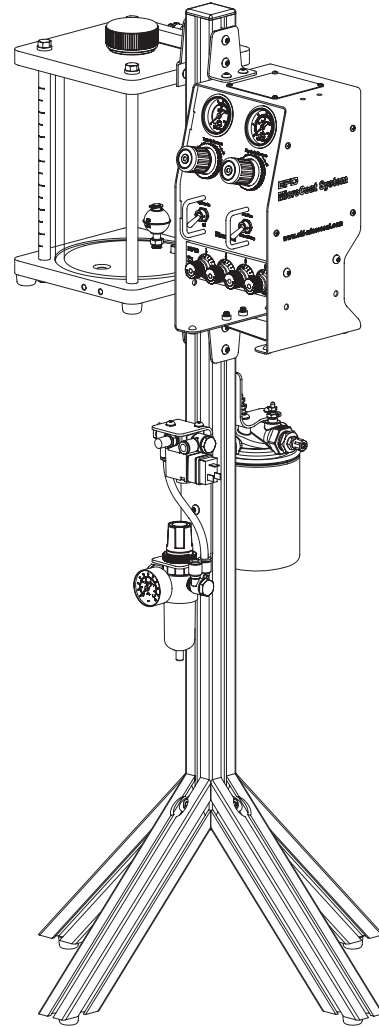

Nordson EFD Product Safety Statement

WARNING

The safety message that follows has a WARNING level hazard.
Failure to comply could result in death or serious injury.



ELECTRIC SHOCK

Risk of electric shock. Disconnect power before removing covers and / or disconnect, lock out, and tag switches before servicing electrical equipment. If you receive even a slight electrical shock, shut down all equipment immediately. Do not restart the equipment until the problem has been identified and corrected.

CAUTION

The safety messages that follow have a CAUTION level hazard.
Failure to comply may result in minor or moderate injury.



READ MANUAL

Read manual for proper use of this equipment. Follow all safety instructions. Task- and equipment-specific warnings, cautions, and instructions are included in equipment documentation where appropriate. Make sure these instructions and all other equipment documents are accessible to persons operating or servicing equipment.



MAXIMUM AIR PRESSURE

Unless otherwise noted in the product manual, the maximum air input pressure is 7.0 bar (100 psi). Excessive air input pressure may damage the equipment. Air input pressure is intended to be applied through an external air pressure regulator rated for 0 to 7.0 bar (0 to 100 psi).



RELEASE PRESSURE

Release hydraulic and pneumatic pressure before opening, adjusting, or servicing pressurized systems or components.



BURNS

Hot surfaces! Avoid contact with the hot metal surfaces of heated components. If contact can not be avoided, wear heat-protective gloves and clothing when working around heated equipment. Failure to avoid contact with hot metal surfaces can result in personal injury.

Nordson EFD Product Safety Statement (continued)

Halogenated Hydrocarbon Solvent Hazards

Do not use halogenated hydrocarbon solvents in a pressurized system that contains aluminum components. Under pressure, these solvents can react with aluminum and explode, causing injury, death, or property damage. Halogenated hydrocarbon solvents contain one or more of the following elements.

Element	Symbol	Prefix
Fluorine	F	“Fluoro-”
Chlorine	Cl	“Chloro-”
Bromine	Br	“Bromo-”
Iodine	I	“Iodo-”

Check the Safety Data Sheet (SDS) or contact your material supplier for more information. If you must use halogenated hydrocarbon solvents, contact your EFD representative for compatible EFD components.

High Pressure Fluids

High pressure fluids, unless they are safely contained, are extremely hazardous. Always release fluid pressure before adjusting or servicing high pressure equipment. A jet of high pressure fluid can cut like a knife and cause serious bodily injury, amputation, or death. Fluids penetrating the skin can also cause toxic poisoning.

WARNING

Any injury caused by high pressure liquid can be serious. If you are injured or even suspect an injury:

- Go to an emergency room immediately.
- Tell the doctor that you suspect an injection injury.
- Show the doctor the following note.
- Tell the doctor what kind of material you were dispensing.

Medical Alert — Airless Spray Wounds: Note to Physician

Injection in the skin is a serious traumatic injury. It is important to treat the injury surgically as soon as possible. Do not delay treatment to research toxicity. Toxicity is a concern with some exotic coatings injected directly into the bloodstream.

Qualified Personnel

Equipment owners are responsible for making sure that EFD equipment is installed, operated, and serviced by qualified personnel. Qualified personnel are those employees or contractors who are trained to safely perform their assigned tasks. They are familiar with all relevant safety rules and regulations and are physically capable of performing their assigned tasks.

Nordson EFD Product Safety Statement (continued)

Intended Use

Use of EFD equipment in ways other than those described in the documentation supplied with the equipment may result in injury to persons or damage to property. Some examples of unintended use of equipment include:

- Using incompatible materials.
- Making unauthorized modifications.
- Removing or bypassing safety guards or interlocks.
- Using incompatible or damaged parts.
- Using unapproved auxiliary equipment.
- Operating equipment in excess of maximum ratings.
- Operating equipment in an explosive atmosphere.

Regulations and Approvals

Make sure all equipment is rated and approved for the environment in which it is used. Any approvals obtained for Nordson EFD equipment will be voided if instructions for installation, operation, and service are not followed. If the equipment is used in a manner not specified by Nordson EFD, the protection provided by the equipment may be impaired.

Personal Safety

To prevent injury, follow these instructions:

- Do not operate or service equipment unless you are qualified.
- Do not operate equipment unless safety guards, doors, and covers are intact and automatic interlocks are operating properly. Do not bypass or disarm any safety devices.
- Keep clear of moving equipment. Before adjusting or servicing moving equipment, shut off the power supply and wait until the equipment comes to a complete stop. Lock out power and secure the equipment to prevent unexpected movement.
- Make sure spray areas and other work areas are adequately ventilated.
- When using a syringe barrel, always keep the dispensing end of the tip pointing towards the work and away from the body or face. Store syringe barrels with the tip pointing down when they are not in use.
- Obtain and read the Safety Data Sheet (SDS) for all materials used. Follow the manufacturer's instructions for safe handling and use of materials and use recommended personal protection devices.
- Be aware of less-obvious dangers in the workplace that often cannot be completely eliminated, such as hot surfaces, sharp edges, energized electrical circuits, and moving parts that cannot be enclosed or otherwise guarded for practical reasons.
- Know where emergency stop buttons, shutoff valves, and fire extinguishers are located.
- Wear hearing protection to protect against hearing loss that can be caused by exposure to vacuum exhaust port noise over long periods of time.

Nordson EFD Product Safety Statement (continued)

Fire Safety

To prevent a fire or explosion, follow these instructions:

- Shut down all equipment immediately if you notice static sparking or arcing. Do not restart the equipment until the cause has been identified and corrected.
- Do not smoke, weld, grind, or use open flames where flammable materials are being used or stored.
- Do not heat materials to temperatures above those recommended by the manufacturer. Make sure heat monitoring and limiting devices are working properly.
- Provide adequate ventilation to prevent dangerous concentrations of volatile particles or vapors. Refer to local codes or the SDS for guidance.
- Do not disconnect live electrical circuits when working with flammable materials. Shut off power at a disconnect switch first to prevent sparking.
- Know where emergency stop buttons, shutoff valves, and fire extinguishers are located.

Preventive Maintenance

As part of maintaining continuous trouble-free use of this product, Nordson EFD recommends the following simple preventive maintenance checks:

- Periodically inspect tube-to-fitting connections for proper fit. Secure as necessary.
- Check tubing for cracks and contamination. Replace tubing as necessary.
- Check all wiring connections for looseness. Tighten as necessary.
- Clean: If a front panel requires cleaning, use a clean, soft, damp rag with a mild detergent cleaner. DO NOT USE strong solvents (MEK, acetone, THF, etc.) as they will damage the front panel material.
- Maintain: Use only a clean, dry air supply to the unit. The equipment does not require any other regular maintenance.
- Test: Verify the operation of features and the performance of equipment using the appropriate sections of this manual. Return faulty or defective units to Nordson EFD for replacement.
- Use only replacement parts that are designed for use with the original equipment. Contact your Nordson EFD representative for information and advice.

Nordson EFD Product Safety Statement (continued)

Important Disposable Component Safety Information

All Nordson EFD disposable components, including syringe barrels, cartridges, pistons, tip caps, end caps, and dispense tips, are precision engineered for one-time use. Attempting to clean and re-use components will compromise dispensing accuracy and may increase the risk of personal injury.

Always wear appropriate protective equipment and clothing suitable for your dispensing application and adhere to the following guidelines:

- Do not heat syringe barrels or cartridges to a temperature greater than 38° C (100° F).
- Dispose of components according to local regulations after one-time use.
- Do not clean components with strong solvents (MEK, acetone, THF, etc.).
- Clean cartridge retainer systems and barrel loaders with mild detergents only.
- To prevent fluid waste, use Nordson EFD SmoothFlow™ pistons.

Action in the Event of a Malfunction

If a system or any equipment in a system malfunctions, shut off the system immediately and perform the following steps:

1. Disconnect and lock out system electrical power. If using hydraulic and pneumatic shutoff valves, close and relieve pressure.
2. For Nordson EFD air-powered dispensers, remove the syringe barrel from the adapter assembly. For Nordson EFD electro-mechanical dispensers, slowly unscrew the barrel retainer and remove the barrel from the actuator.
3. Identify the reason for the malfunction and correct it before restarting the system.

Disposal

Dispose of equipment and materials used in operation and servicing according to local codes.

Specifications

NOTE: Specifications and technical details are subject to change without prior notification.

MC800 Controller

Item	Specification
Cabinet size	14.6 _W x 19.1 _D x 27.6 _H cm (5.75 _W x 7.50 _D x 10.88 _H ")
Weight	4.8 kg (10.6 lb)
Cycle rate	Up to 60 per minute
Pressure switch rating	20VA, 240V
Input air pressure	4.1 bar (60 psi) minimum
Tank air pressure regulator	2.0 bar (30 psi) maximum
Nozzle air regulator	2.0 bar (30 psi) maximum
Approvals	CE, UKCA

MC785M & MC785M-WF Valves

Item	Specification
Size (with fittings)	66.3 _L x 49.3 _{DIA} mm (2.61 _L x 1.94 _{DIA} ")
Weight	206.4 g (7.3 oz)
Lubricant inlet hole	1/8 NPT
Mounting	6 mm tapped hole
Cycle rate	Up to 60 per minute
Lubricant chamber	Hard-coated anodized aluminum
Air cap	303 stainless steel
Diaphragm	Viton [®] with PTFE coating
Needle and nozzle	303 stainless steel
Nozzle diameter	1.17 mm (0.046")

U.S. Patent No. D-398,705

Specifications (continued)

MicroCoat Tank Reservoirs

Item	Specification
Operating pressure	2.0 bar (30 psi) maximum
Safety relief pressure	2.8 bar (40 psi)
Low level switch rating	20VA, 240V
Capacity	MC685M (P/N 7023843): 3.8 L (1.0 gal) MC686M (P/N 7023846): 7.5 L (2.0 gal)
Construction	Acrylic tank wall, anodized aluminum end caps
Weight	MC685M (P/N 7023843): 4.1 kg (9.2 lb) MC686M (P/N 7023846): 5.2 kg (11.6 lb)

4000FLT MC Filter Elements

Item	Specification
Internal filter element	Resin impregnated cellulose media
Micron filter size	10 micron nominal

Declaration of Conformity



EC Declaration of Conformity

In Accordance with EN ISO/IEC 17050-1:2010

Manufacturer: Nordson EFD LLC
Address: 40 Catamore Blvd.
East Providence RI. 02914

Type of Equipment: Pneumatic spray valve system
Product Name: MC800 Microcoat Lubrication System
Model & Part Number: MC800, MC800-15, MC785M, MC785M-WF, 8101,
8101NPS, MC685M, MC686M, MC687M,
MC687M-DFS

Manufacture Date: _____ Serial Number: _____

The above (MC800 Family) listed product(s) have been evaluated for conformity to:

2006/42/EC The Machinery Directive

The standards to which conformity is declared are:

EN/ISO 4414 Pneumatic fluid power -- General rules and safety requirements for systems and their components

Nordson EFD LLC

Sr. Quality Assurance Manager
East Providence, RI, USA
Date: February 7, 2019

Authorized Representative:
European Technical and
Quality Manager
Nordson Deutschland GmbH
Nordson EFD Branch Office
Raiffeisenalle. 12b
82041 Oberhaching
Germany

How the System Operates

The MicroCoat System incorporates up to eight low volume low pressure (LVLP) spray valves, a lubricant reservoir, and a controller that regulates air pressure, meters lubricant flow, and controls valve operation.

Constant air pressure applied to the tank reservoir forces lubricant through precision fluid flow controls on the MC800 controller, then out to the spray valves.

When the press is stamping, a 3-way air solenoid activates the system and opens the valves.

As the valve opens, LVLP air creates a pressure drop at the nozzle, causing the lubricant to spray a fine film onto the stock.

Lubricant flow can be adjusted independently for each valve via flow controls on the front of the MC800 controller.

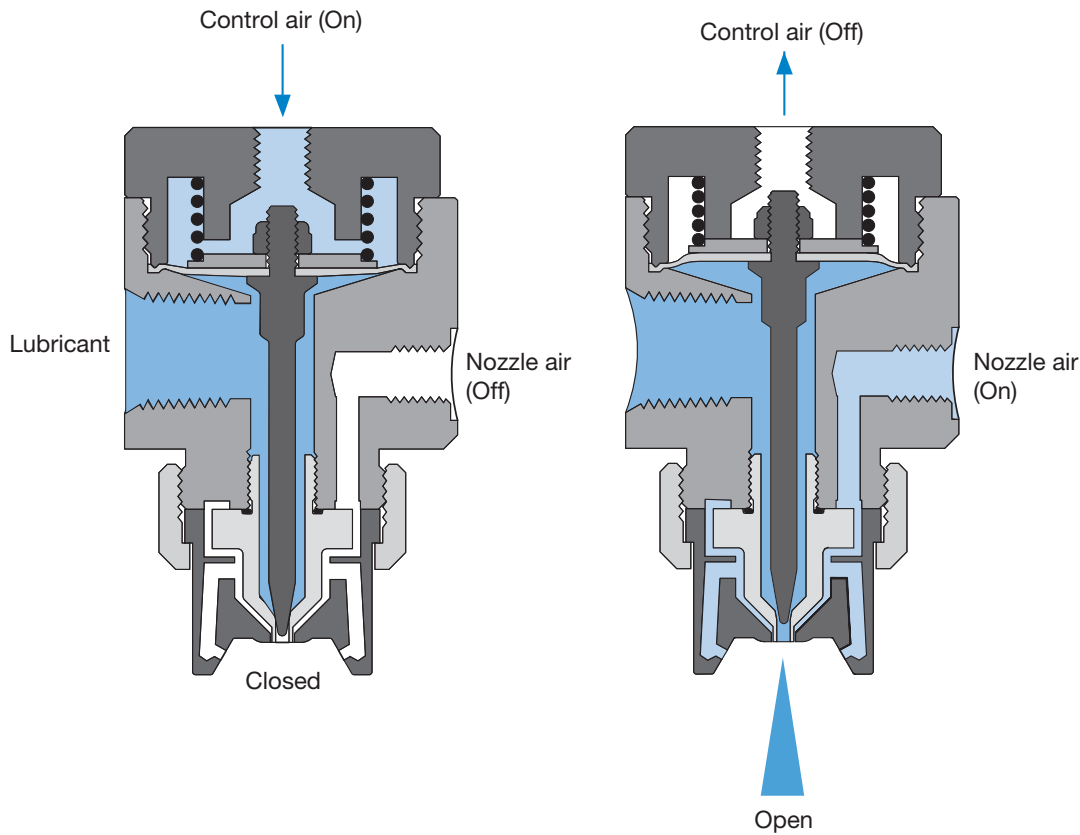

Controller Features

- 1. System Pressure Switch**
Turns the system air supply On and Off.
- 2. Mode Switch**
Use Manual/Setup position to prime and test the valves without running the press.
In the Auto/Run position, the system will spray lubricant when the press begins stamping.
Press air solenoid must be properly installed to allow the MicroCoat System to run in Auto/Run mode (refer to pages 18–19).
- 3. Tank Air Pressure**
Regulates air pressure in the lubricant reservoir. For most lubricants, 1.03 bar (15 psi) is a good start.
Minimum setting is 0.83 bar (12 psi).
- 4. Nozzle Air**
Regulates nozzle air pressure.
Average setting is 0.55 to 0.83 bar (8 to 12 psi). Higher pressure provides finer spray.
- 5. Flow Controls**
Provide independent flow control of the lubricant to each spray valve. Each blue ring on the stem coming out of the middle of the knob indicates one complete revolution.
Turn counterclockwise to increase flow.

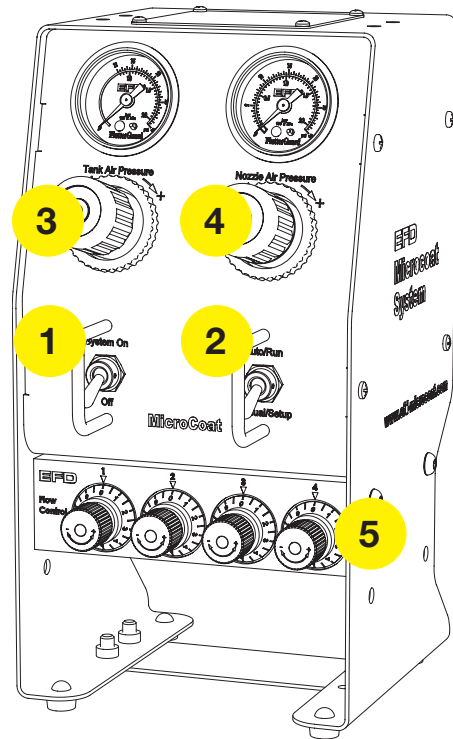

Controller Features (continued)

6. Low Pressure Switch

Registers low fluid pressure. Connects with low level switch for press protection.

WARNING

Must be wired to the press Emergency Stop Circuit to prevent the press from operating without lubricant pressure (refer to page 22).

7. Tank Air

Air from this port pressurizes the lubricant reservoir.

8. Nozzle Air

Air from this port is used to spray the lubricant.

9. Valve, control air

Air from this port controls the opening and closing of the spray valves.

10. Fluid Outlet

Pressurized lubricant flows from these ports to the spray valves.

11. Constant Air Input

The main air supply to the system should be a minimum of 4.14 bar (60 psi).

12. Fluid Inlet

Lubricant from the tank reservoir enters the manifold through this port.

13. Control Air Input from Solenoid

Activates the system when the press begins stamping. Minimum 4.14 bar (60 psi) required.

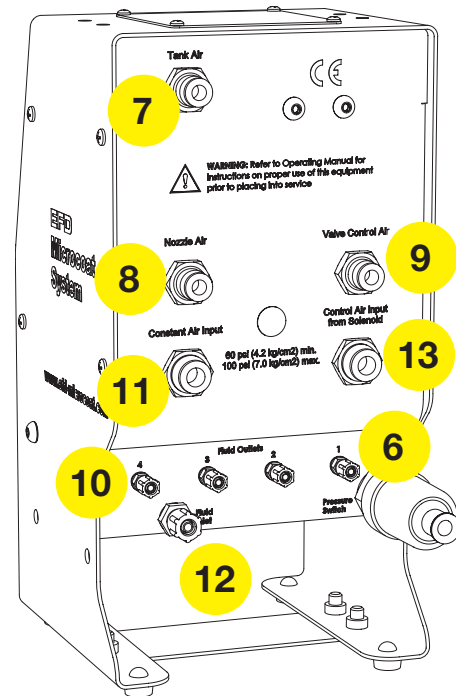

Tank Reservoir Features

1. Low Level Switch

Prevents the system from operating without lubricant when connected to the press Emergency Stop Circuit. Switch opens when tank level is near empty.

2. Air Pressure Relief Valve

Automatically exhausts air if tank reservoir pressure exceeds 2.76 bar (40 psi). Also used to manually exhaust air pressure before refilling the tank.

3. Fill Port Cap

Ported threads relieve any residual reservoir air pressure when cap is loosened.

4. Drain Plug (not shown)

5. Lubricant Inline Filter

6. Bleed Valve

Valve releases air after filter replacement.

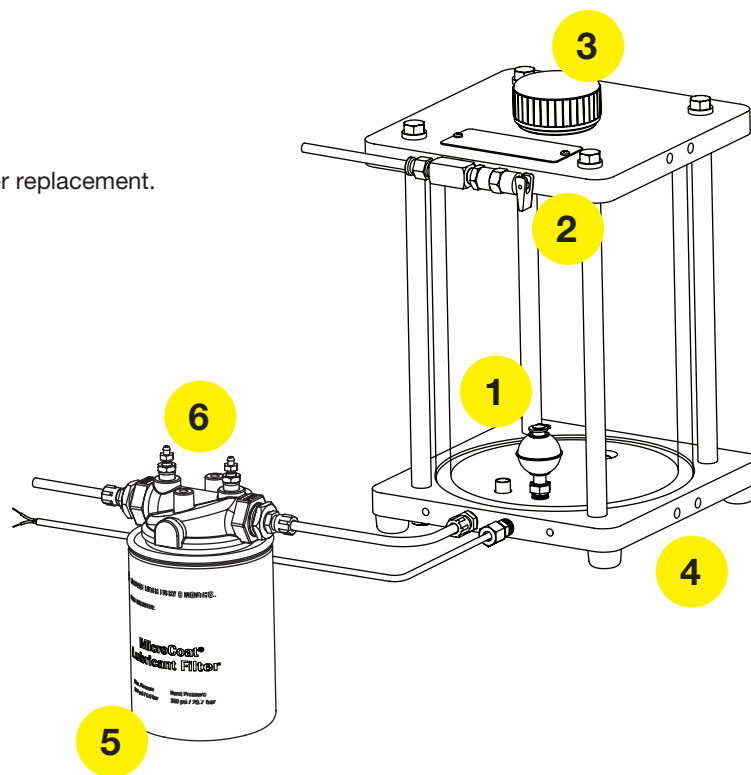

System Assembly

Mount the Spray Valves

Mount each valve with the mounting clamp (P/N 7021742) provided, or use the 6 mm mounting hole in the valve body to attach the valve to an alternative mounting bracket.

To ensure proper lubrication coverage, mount the MC785M valve so the tabs on the air cap are in line with the stock as illustrated.

IMPORTANT: If you loosen the air cap retainer nut to reposition the tabs, be sure to re-tighten the nut with a wrench before operating the valve.

The width of spray coverage is determined by the distance between the valve nozzle and the stock, as shown in the chart below.

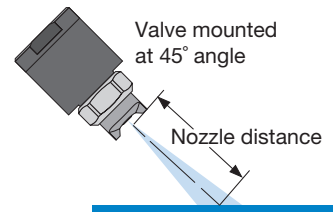
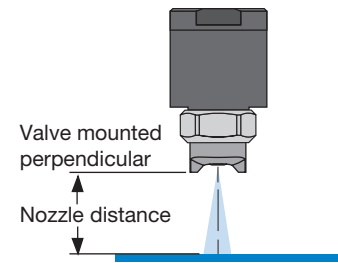
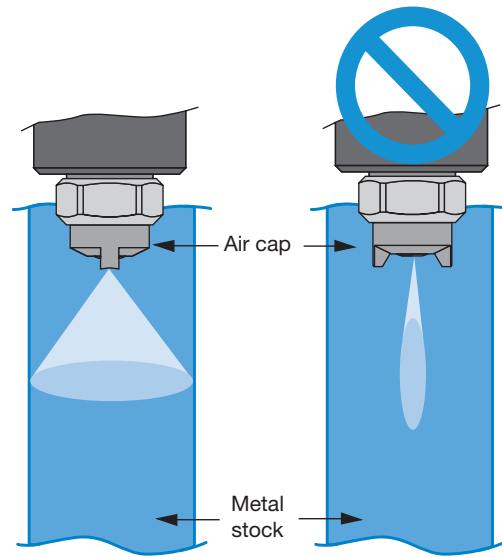

Spray Area Coverage

Spray Valves	Nozzle Distance to Stock					
	2.54 mm (0.1")	50.8 mm (2.00")	76.2 mm (3.00")	101.6 mm (4.00")	127.0 mm (5.00")	152.4 mm (6.00")
MC785M	25.4 mm (1.00")	38.1 mm (1.50")	50.8 mm (2.00")	63.5 mm (2.50")	69.9 mm (2.75")	82.6 mm (3.25")
MC785M-WF	38.1 mm (1.50")	63.5 mm (2.50")	88.9 mm (3.50")	114.3 mm (4.50")	139.7 mm (5.50")	165.1 mm (6.50")

The MC785M-WF is recommended for spray widths from 2.0" to 6.0".

NOTE: Spray width coverage may vary depending on the viscosity and surface tension of the fluid.

System Assembly (continued)

Installation / Removal of Flow Control / Block-off Plug from Manifold

CAUTION

Turn the system pressure off and confirm that tank pressure is at zero before performing maintenance on the system.

To remove a block-off plug or flow control, loosen the set screw on the bottom of the fluid manifold block and pull the block-off or flow control out of the manifold.

NOTE: To loosen / release the block-off and / or the flow control from the manifold, it may help to rotate them clockwise while you pull. This will help free the O-ring seal. The flow control needs to be fully closed before the body will turn within the manifold.

To install a new flow control, lubricate the O-rings on the flow control with your stamping oil and push the flow control into the manifold while turning clockwise until the flow control slides into place. Continue turning until the zero on the knob is lined up with the zero reference on the flow control manifold. Tighten the manifold setscrew firmly.

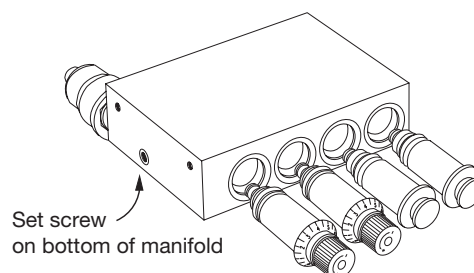

Set Up the Controller

1. Place the controller and tank reservoir away from traffic areas and position the tank to allow for convenient refilling.
2. Set the controller System Pressure to the Off position and the mode switch to the Auto/Run position.
3. Refer to the diagram on page 19 and connect a five-micron filter / regulator to the plant air supply. Using the black and white 8 mm hoses supplied with the controller, connect to the color-coded Constant Air Input (black, 8 mm) and Control Air Input from Solenoid (white, 8 mm) fittings at the back of the controller.

Connect the Press Air Solenoid

IMPORTANT: When the press is stamping, the solenoid must be open continuously to allow constant spray from the MicroCoat system. This can be accomplished by wiring the solenoid into the press clutch / run circuit.

To provide proper air distribution and control, a press air solenoid must be installed in-line with the white hose going to the Control Air Input from Solenoid Fitting.

1. Select the appropriate 3-way solenoid. Flow must meet or exceed 0.06 m³/min (2.0 cfm) at 4.14 bar (60 psi).
2. Cut the control air hose at a convenient location and install the solenoid as shown.
3. Connect the solenoid wires to the press control circuit.

System Assembly (continued)

Press Air Solenoid Diagram

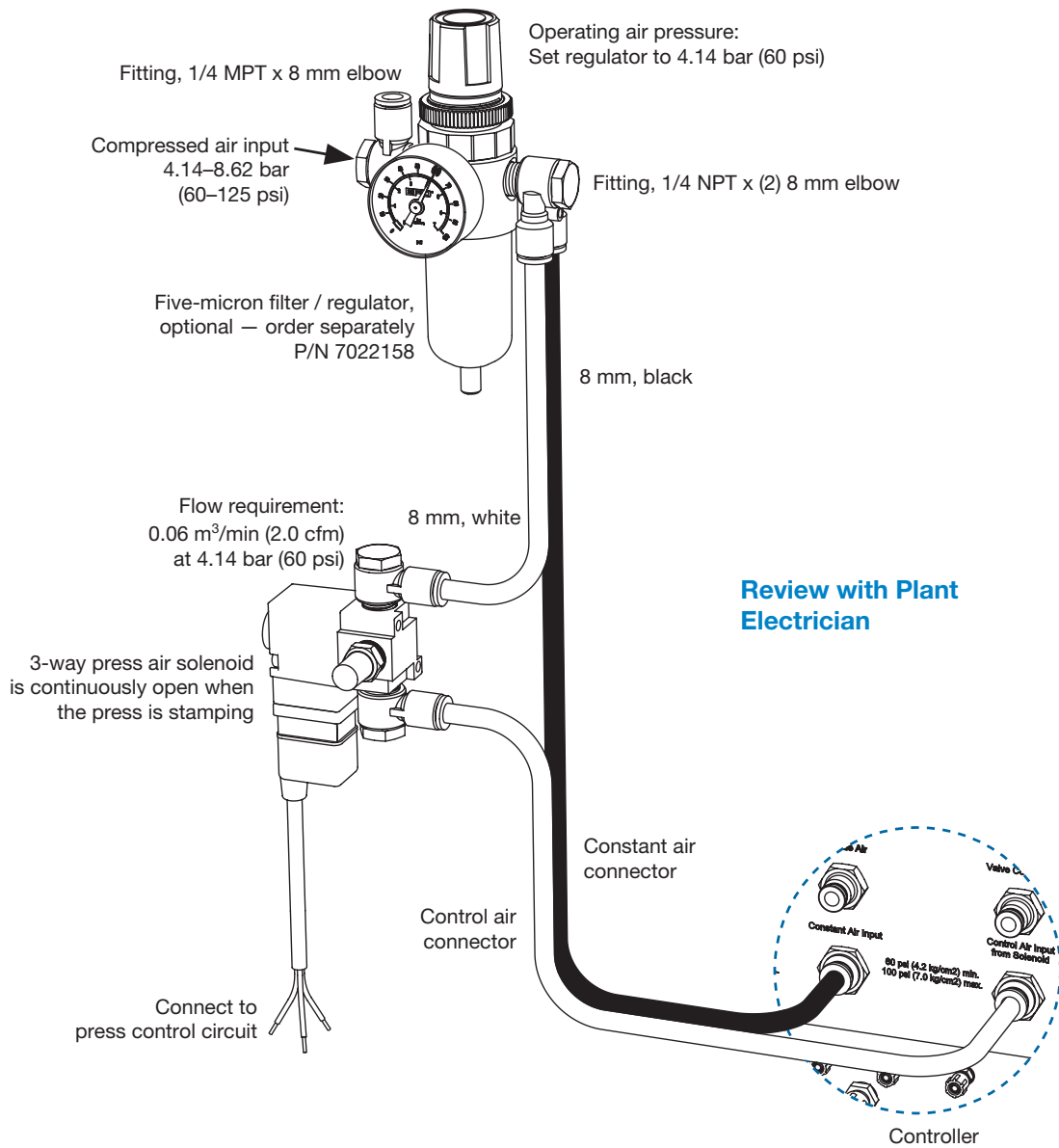

System Assembly (continued)

Connect the Valve Hoses

NOTE: Refer to the diagram on page 21.

1. Find a suitable location and mount the two air manifolds. One manifold is for the white Control Air hose and the other is for the black Nozzle Air hose.
2. Connect a suitable length of black 6 mm tubing between the valve controller Nozzle Air outlet fitting and the air manifold inlet which has black push-in fittings.
3. Connect a suitable length of white 6 mm tubing between the valve controller Control Air outlet fitting and the air manifold inlet which has white push-in fittings.
4. Using the black and white 4 mm tubing, connect each color-coded valve fitting to the appropriate colored manifold fitting, cutting the tubing to the appropriate length as you proceed.
5. Using the clear 4 mm tubing, connect the appropriate length of tubing to the fluid manifold at the back of the controller using the compression nut provided and connect the opposite end to the appropriate spray valve inlet push-in fitting.
6. Using the spiral wrap supplied, group and wrap each valve tri-hose to provide a neat installation and prevent damage due to loose hoses.

Connect the Tank Reservoir and Lubricant Filter

NOTE: Refer to the diagram on page 21.

The tank reservoir is supplied with a lubricant filter, fluid hose, air hose and low level switch cable.

Connect the tank to the controller as follows:

1. Connect the gray air hose to the Tank Air fitting on the back of the controller. Connect the opposite end of the hose to the Tank Air Inlet fitting on top of the tank.
2. Mount the filter adapter to the tank reservoir or MicroCoat stand using the hardware provided.
3. Connect the clear fluid hose to the Fluid Inlet connector on the manifold at the back of the controller. Then connect the opposite end of the fluid hose to the outlet fitting at the bottom of the tank reservoir.
4. Cut the clear fluid hose from the tank to the controller so the end of the hose coming from the tank can be installed into the "IN" port of the filter adapter.
5. Connect the fluid hose from the controller to the "OUT" port on the filter adapter.
6. Lubricate the filter gasket and screw the filter onto the adapter until the gasket makes contact and then tighten an additional 3/4 turn.
7. Refer to page 22 to wire the press Emergency Stop Circuit and to connect the low level switch cable to the controller.

System Assembly (continued)

System Assembly Diagram

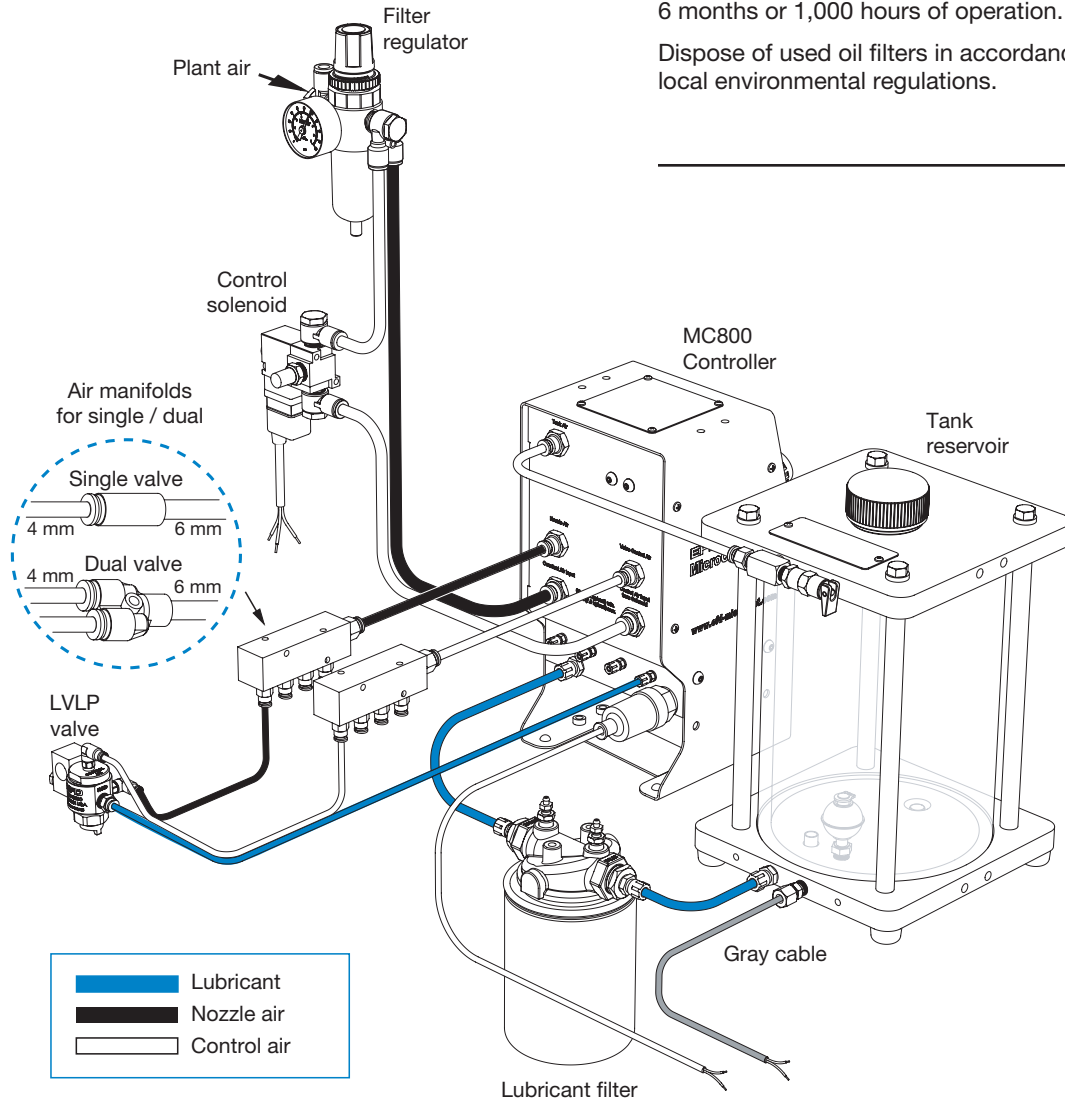

NOTE: If both manifolds are being used with the same fluid supply, install a "T" fitting (supplied) in the lubricant filter outlet port.

Replace filter element P/N 7017347 every 6 months or 1,000 hours of operation.

Dispose of used oil filters in accordance with local environmental regulations.

System Assembly (continued)

Connect the Emergency Stop Circuit

The Emergency Stop Circuit on the press must be properly wired to the MicroCoat System to prevent the press from stamping without lubricant and to alert the operator if the lubricant pressure drops below 0.69 bar (10 psi).

⚠ WARNING

These switches must also be wired in series with the Emergency Stop Circuit from the press. Following integration of this circuit, the end user should review and test the fail-safe operation by turning off the MC800 system pressure switch. The press should not be able to start with this switch in the off position.

Connect the red and black wire to the Emergency Stop Circuit located on the press.

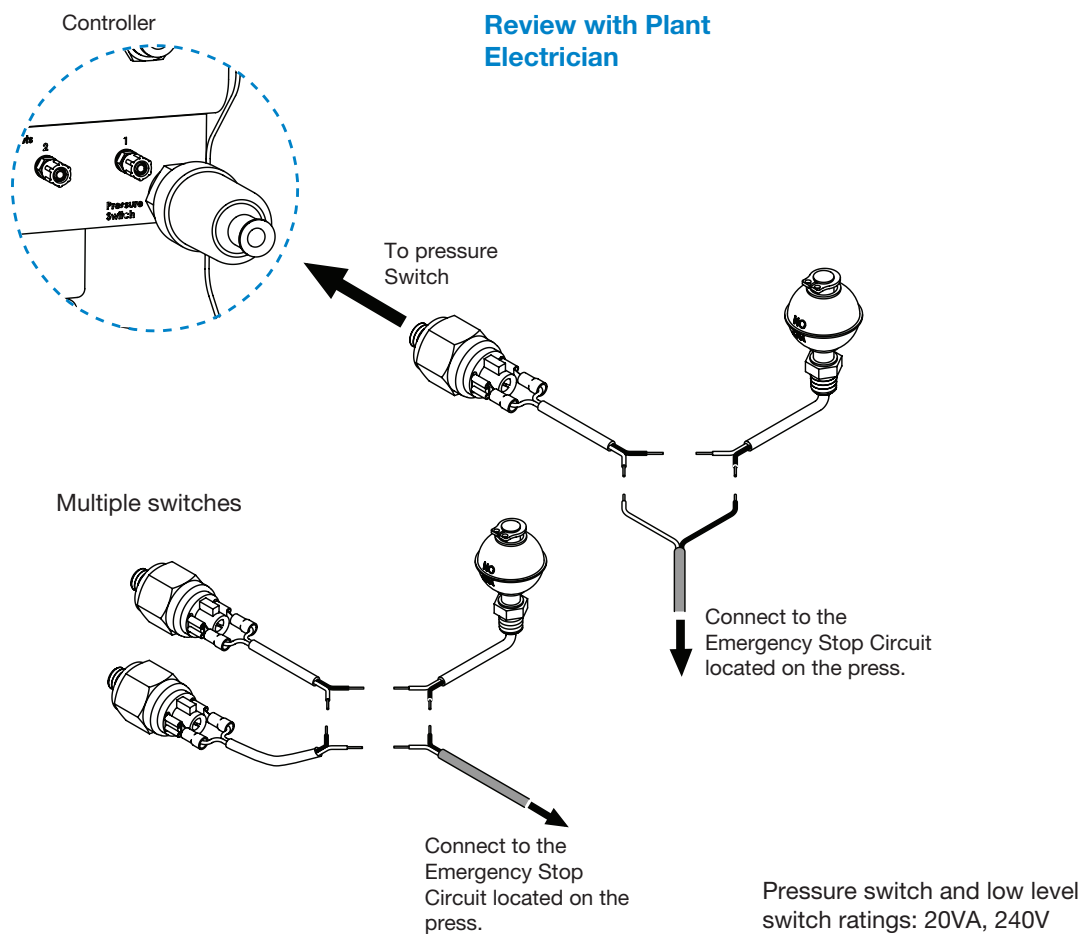

System Setup

Check All Connections

1. Check that all connections are correct and secure.
2. Verify that the System Pressure switch is set to the Off position and the mode switch is set to the Auto/Run position.
3. Check that the input air supply is connected and set at 4.14 bar (60 psi).

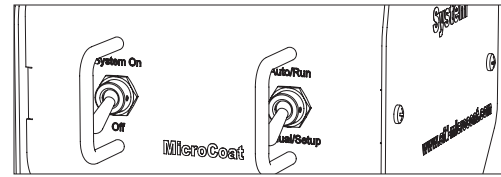

Fill the Tank Reservoir

⚠ CAUTION

Do not overfill. Overfilling may cause lubricant to flow back into the regulator in the regulator in the controller.

1. Unscrew the tank cap and fill the tank reservoir with lubricant to the level indicated on the tank label.
2. Reinstall the tank cap.

Prime the System

1. Set the System Pressure switch to On.
2. Adjust the Tank Air Pressure regulator to 1.03 bar (15 psi). Do not set pressure lower than 0.83 bar (12 psi).
3. Turn the Nozzle Air pressure regulator knob counterclockwise as far as it will go to prevent nozzle air from flowing while priming the valves.

NOTE: Regulator knobs have a push-to-lock, pull-to-unlock feature.

4. Turn all Flow Control knobs completely clockwise until closed.
5. Set the mode switch to Manual/Setup.
6. Open the valve on the filter adapter until all the air is removed.
7. Check for leaks around the filter and all connections between the tank and controller.
8. Select one valve and open the appropriate Flow Control knob about five full turns (counterclockwise) to fill the hose and prime the valve.
9. When the lubricant flows in a steady stream, the valve is primed. Close the Flow Control (turn clockwise).
10. Repeat steps 8 and 9 for each valve.

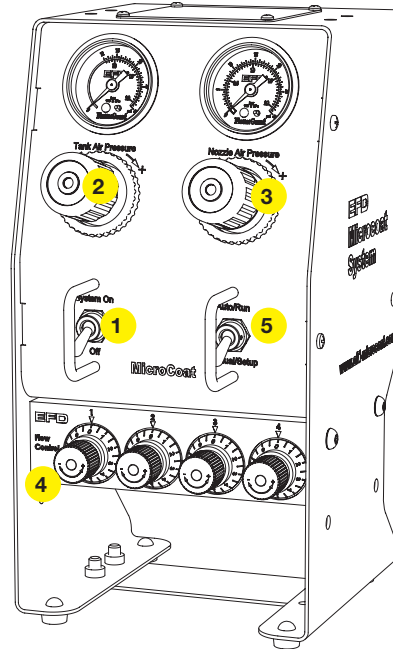

System Setup (continued)

IMPORTANT: Each valve must be fully primed (lubricant flows in a steady stream) before adjusting the spray.

Adjust the Spray

1. As a starting point, select one valve and adjust the Flow Control knob so that lubricant flows from the valve at the rate of approximately one drop per second.
2. Note the number set on the graduated dial of the open Flow Control. Set the flow for each remaining valve to the same setting.
3. Turn the Nozzle Air regulator clockwise until pressure reads between 0.55 to 0.69 bar (8 to 10 psi) and the valve begins to spray. Thicker lubricants may require 0.83 to 1.03 bar (12 to 15 psi). Push the knob in to lock.
4. Set the mode switch to Auto/Run. The spray will shut off. The valves are ready to spray when the press is stamping.
5. After starting the press, adjust the Flow Control knobs as needed to provide proper lubricant coverage.

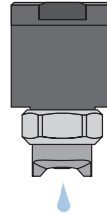

After priming the valve, adjust lubricant flow to a rate of approximately one drop per second.

Preventive Maintenance

The MicroCoat System is designed for long life with minimal maintenance. To ensure trouble-free performance, follow these precautions and preventive maintenance steps.

WARNING

Before performing any maintenance, set the System Pressure Switch to the Off position and depressurize the tank reservoir by lifting the lever on the tank pressure relief valve.

- Always use clean lubricant.
- Check for residue at the bottom of the tank reservoir and clean if necessary.
- Do not clean the MC685M or the MC686M tank with chlorinated solvents, aromatic hydrocarbons or any fluid that will attack acrylics. Use only soap and water, or mineral spirits to clean acrylic tank surfaces.
- Operate the system with clean, dry, oil-free air. Drain the bowl on the five micron filter regulator whenever moisture or oil is present.
- Replace lubricant filter (P/N 7017347) every 6 months or 1,000 hours of operation.
- Dispose of used oil filters in accordance with local environmental regulations.

Spray Valve Maintenance

WARNING

Before performing any maintenance, set the System Pressure Switch to the Off position and depressurize the tank reservoir by lifting the lever on the tank pressure relief valve.

When using filtered plant air and clean lubricants, the MC785M Series spray valves are designed for long-term performance without scheduled maintenance.

If lubricant flow stops or becomes erratic, first review “Troubleshooting” on page 30. Cleaning the nozzle will solve most problems related to lubricant flow and spray patterns.

To Clean the Nozzle

Remove the air cap retainer nut, air cap and nozzle from the outlet end of the valve. Clean and reinstall.

Valve Disassembly

NOTE: Refer to the diagram on page 27.

1. Remove air cap retainer nut, air cap and nozzle from the outlet end of valve.
2. Remove diaphragm chamber cap, diaphragm return spring and needle / diaphragm assembly from the valve body.
3. Remove diaphragm retaining nut and spring locating washer from the needle, then remove and discard old diaphragm.

NOTE: Install a new diaphragm (P/N 7021727) each time the valve is reassembled.

4. Clean all parts in mineral spirits.

Maintenance Tools

8" adjustable wrench
7/8" open end wrench
5/16" box end wrench
1/4" nut driver

Valve Reassembly

NOTE: Refer to the diagram on page 27.

1. Place the new diaphragm over the threaded end of the needle. The black Viton side of the diaphragm should face the threaded end. The blue-gray PTFE side should face the wetted side of the valve.
2. Place the spring locating washer over threaded end of the needle. The stepped side should face the threaded end.
3. Install a new diaphragm retaining nut (included with P/N 7021727 diaphragm) and turn it until the nut starts to feel tight and the diaphragm cannot be rotated on the needle with fingers. Avoid crushing the diaphragm causing it to bulge away from the washer.
4. Install the needle / diaphragm assembly into the valve body, then install diaphragm return spring and diaphragm chamber cap, and tighten firmly.
5. Reinstall the nozzle, air cap and air cap retainer.

The air cap retainer nut should be tightened with a wrench to prevent loosening due to press vibration.

Part Numbers

For all system part numbers, refer to the MicroCoat Lubrication System Parts & Accessories List:

www.nordsonefd.com/MC800PartsAccessories

Accessories

For all available accessories, refer to the MicroCoat Lubrication System Parts & Accessories List:

www.nordsonefd.com/MC800PartsAccessories

Replacement Parts

MC785M Series Spray Valves

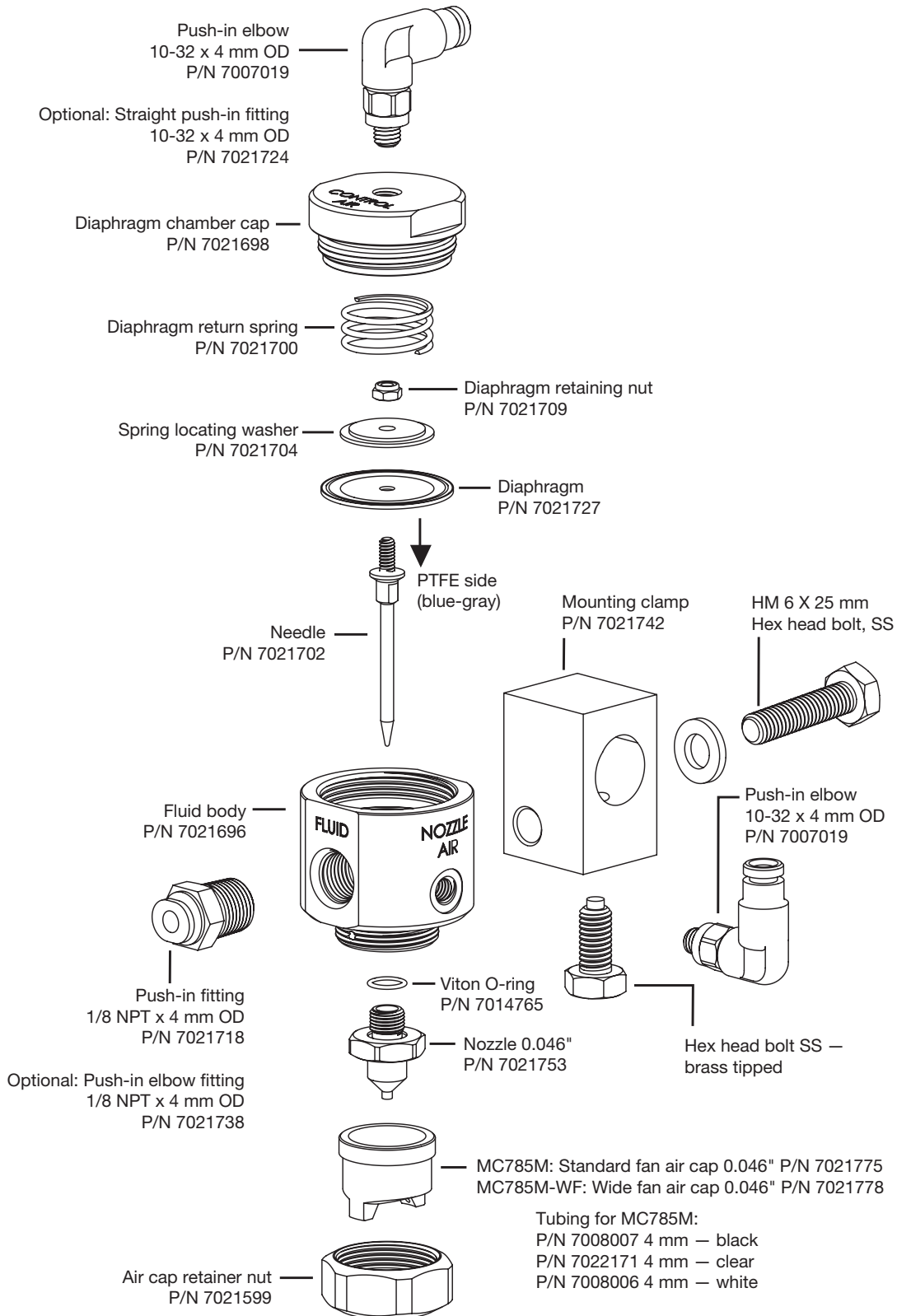

Replacement Parts (continued)

MC685M and MC686M Tanks

Part #	Description
7002004	Blue urethane hose
7020446	Viton O-ring for filler
7020425	(2) Neoprene gaskets for acrylic tube
7020427	(2) Viton gaskets for acrylic tube
7020432	Pressure relief valve 2.76 bar (40 psi)
7022195	Push-in fitting, tank inlet
7020422	Acrylic tube 6.50" D x 8.96" L (one gal)
7020438	Acrylic tube 6.50"D x 16.35"L (two gal)
7022188	1/8" BSPP x 6 mm cap barb fitting, tank outlet
7022175	Black urethane hose
7020442	Filler cap
7020436	Nickel-plated brass drain plug
7020429	Stainless steel float switch kit (includes connector, wiring & strain reliefs)
7022156	Lubricant filter kit
7017347	Lubricant filter element, (4) per box

Troubleshooting

Problem	Possible Cause and Correction
Air pressure regulator will not maintain set pressure	Contaminated air supply. Remove the controller cover to access the regulator. Remove the brass hex plug, spring, and poppet from the regulator. Clean the poppet and reinstall the poppet, spring, and plug.
No lubricant flow to valve	<p>Tank pressure may be too low. Minimum operating tank air pressure is 0.83 bar (12 psi).</p> <p>Hose connector may not be pushed fully into the fluid outlet fitting on the rear panel of the controller. Ensure connector is firmly seated.</p> <p>Check fluid hose for kinks.</p>
Valves do not turn on	Supply pressure to controller must be at 4.1 bar (60 psi).
Lubricant flows but valve does not spray	<p>Air cap may be clogged. Be sure oil tank filter is clean. Remove air cap and clean the inside of the air cap and the outside of the nozzle. Refer to “Spray Valve Maintenance” on page 25.</p> <p>Nozzle air pressure regulator may be set too low. Increase pressure as needed. Normal working range is within 0.55–1.03 bar (8–15 psi).</p>
Valve drips after shutdown	<p>Dripping can be caused by improper seating of the needle in the nozzle. Clean the needle and nozzle, and replace any worn or damaged parts.</p> <p>Ensure nozzle is tight to seat the needle properly.</p>

Technical Data

Air Flow Schematic

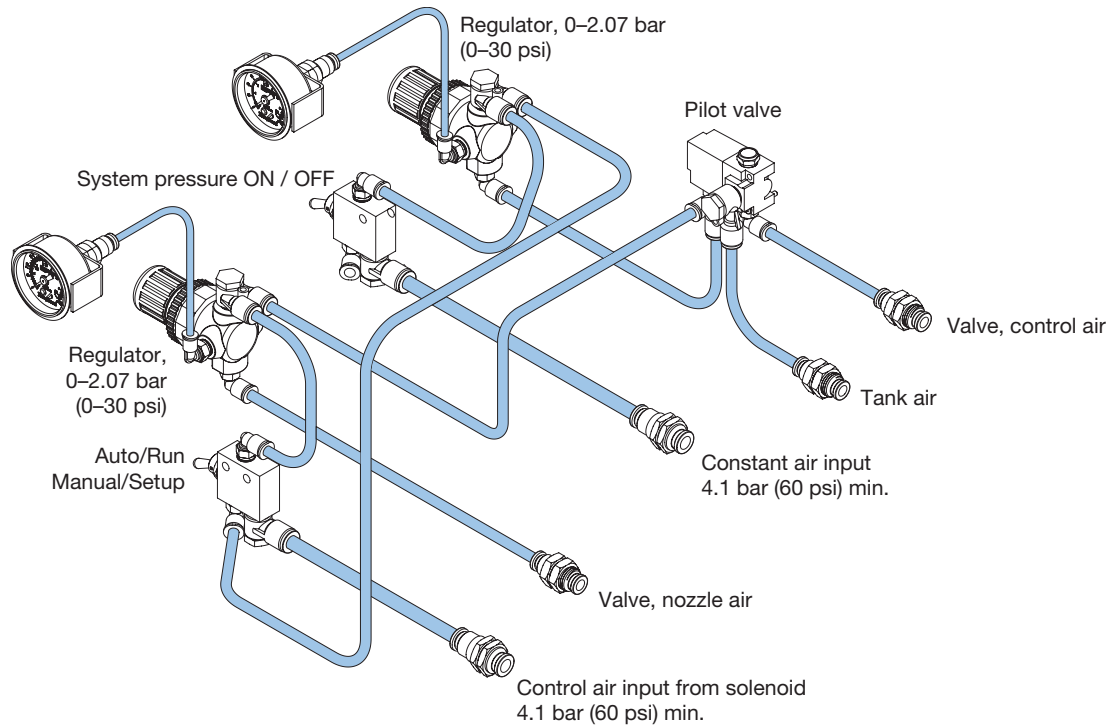

Fluid Flow Schematic

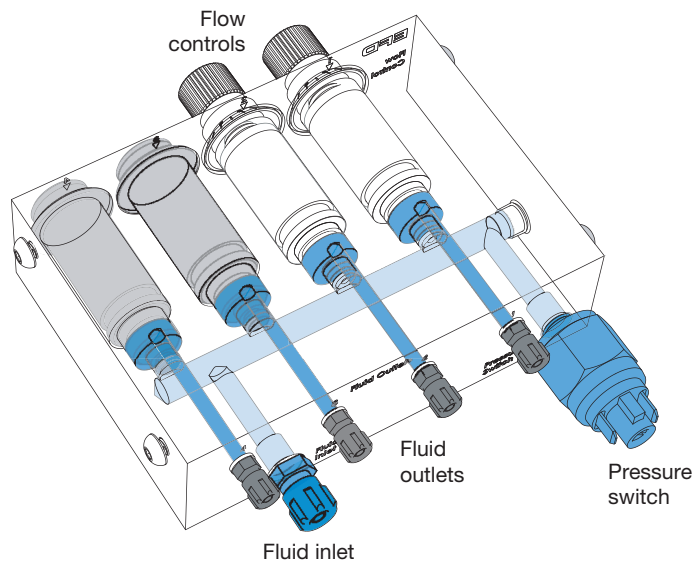

NORDSON EFD TWO YEAR LIMITED WARRANTY

This Nordson EFD product is warranted for two years from the date of purchase to be free from defects in material and workmanship (but not against damage caused by misuse, abrasion, corrosion, negligence, accident, faulty installation, or by dispensing material incompatible with equipment) when the equipment is installed and operated in accordance with factory recommendations and instructions.

Nordson EFD will repair or replace free of charge any defective part upon authorized return of the part prepaid to our factory during the warranty period. The only exceptions are those parts which normally wear and must be replaced routinely, such as, but not limited to, valve diaphragms, seals, valve heads, needles, and nozzles.

In no event shall any liability or obligation of Nordson EFD arising from this warranty exceed the purchase price of the equipment.

Before operation, the user shall determine the suitability of this product for its intended use, and the user assumes all risk and liability whatsoever in connection therewith. Nordson EFD makes no warranty of merchantability or fitness for a particular purpose. In no event shall Nordson EFD be liable for incidental or consequential damages.

This warranty is valid only when oil-free, clean, dry, filtered air is used, where applicable.



For Nordson EFD sales and service in over 40 countries, contact Nordson EFD or go to www.nordsonefd.com.

Global

800-556-3484; +1-401-431-7000
info@nordsonefd.com

Europe

00800 7001 7001
infoefd.europe@nordsonefd.com

Asia

China: +86 (21) 3866 9006; china@nordsonefd.com
India: +91 80 4021 3600; india@nordsonefd.com
Japan: +81 03 5762 2760; japan@nordsonefd.com
Korea: +82-31-736-8321; korea@nordsonefd.com
SEAsia: +65 6796 9522; sin-mal@nordsonefd.com

Viton is a registered trademark of E.I. DuPont.
The Wave Design is a trademark of Nordson Corporation.
©2024 Nordson Corporation 7023880 v050224